

# 2022 SPRING DEALER WORKBOOK



2022

# BASEBALL GLOVES

## GLOVES

BASEBALL GLOVES	01
FASTPITCH GLOVES	22
SLOWPITCH GLOVES	28
GLOVE CARE	29

## LTM-AUTISM SPEAKS

GLOVES & PROTECTIVE	30
---------------------	----

## BATS

BASEBALL BATS	31
FASTPITCH BATS	42
SLOWPITCH BATS	47
WOOD BATS	49

## PROTECTIVE GEAR

CATCHER'S GEAR	66
UMPIRE GEAR	74
PROTECTIVE GEAR	79
BATTING HELMETS	86
BATTING GLOVES	90

## BASEBALLS & SOFTBALLS

BASEBALLS	94
SOFTBALLS	99
SLOWPITCH BALLS	102

## BAGS

DEMARINI	105
LOUISVILLE SLUGGER	108
EVOSHIELD	111
WILSON	114

## ATEC

ATEC	116
------	-----

## UNIFORM & APPAREL

BASEBALL STOCK	131
BASEBALL APPAREL	138
FASTPITCH STOCK	159
FASTPITCH APPAREL	164
HATS	175

## SECTION BRANDS

WILSON

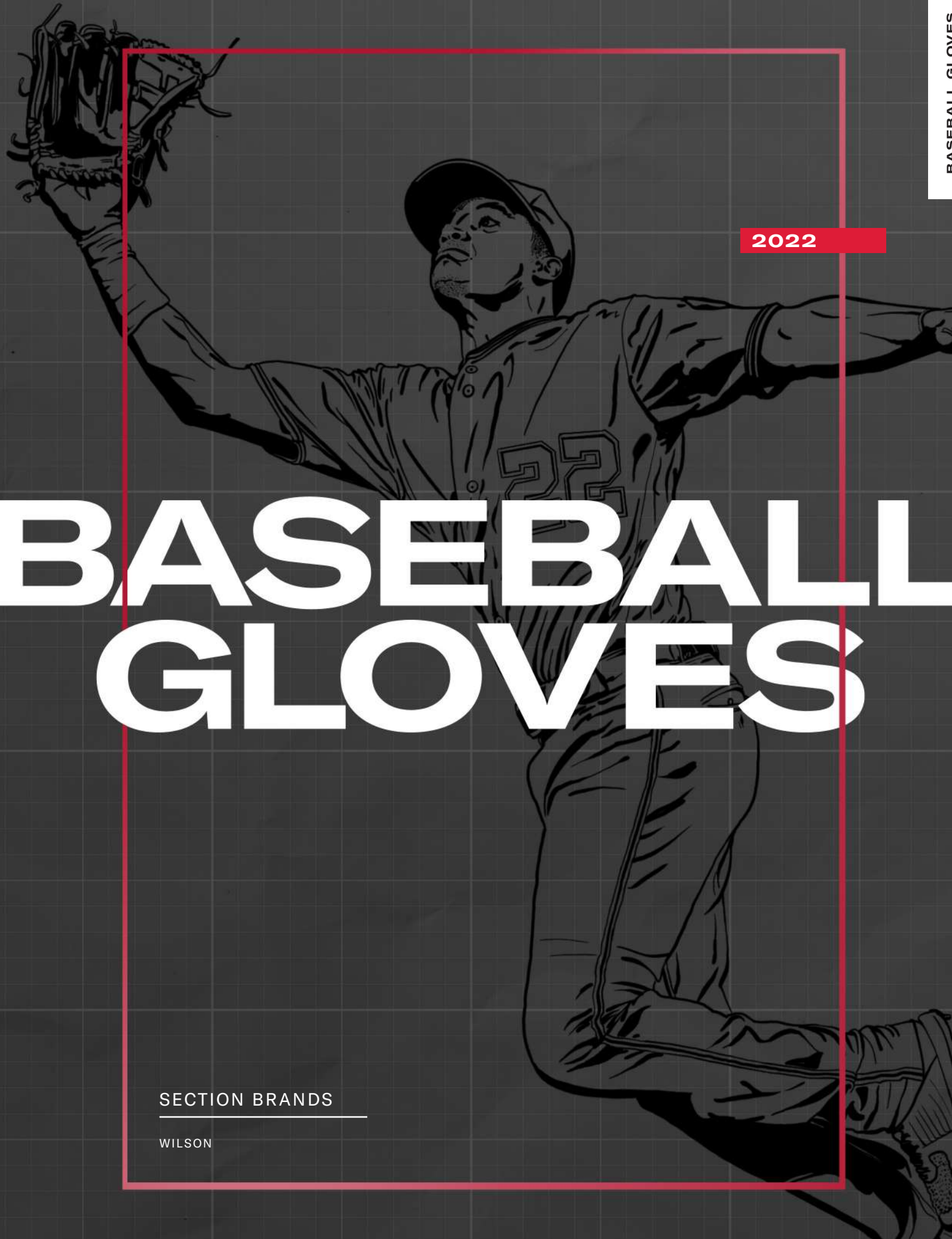

# WILSON®

## ADVISORY STAFF



**TIM ANDERSON**  
Chicago, SS  
A2000 TA7 GM



**KE'BRYAN HAYES**  
Pittsburgh, 3B  
A2000 KBH13 GM



**MONICA ABBOTT**  
Team USA, P  
A2000 MA14 GM

### ARIZONA

Jeremy Beasley - A2000 ASO  
Seth Beer - A2000 1883  
Stuart Fairchild - A2000 1799  
Levi Kelly - A2K D33

Corbin Martin - A2K B2  
David Peralta - A2000 ELO  
Gerald Perdomo - A2000 1788  
Josh Rojas - A2000 OT7

### CINCINNATI

Aristides Aquino - A2000 1775  
Jose De Leon - A2000 HG12  
Sean Doolittle - A2000 XLC  
Kyle Farmer - A2000 1785  
Jose Israel Garcia - A2K 1787  
Dee Gordon - A2000 1786  
Austin Hendrick - A2000 Y

Cionel Perez - A2000 B2  
Tony Santillan - A2000 B2  
Nick Senzel - A2000 KP92  
Lucas Sims - A2K D33  
Tyler Stephenson - A2000 M2  
Jesse Winker - A2000 JH32

### LOS ANGELES (AL)

Jo Adell - A2K 1799  
Franklin Barreto - A2000 PPO5  
Alex Cobb - A2K B2

Kyle Keller - A2K B2  
Brandon Marsh - A2000 Y

### ATLANTA

Ozzie Albies - A2K OA1  
Ian Anderson - A2000 D33  
Johan Camargo - A2000 EL3  
Grant Dayton - A2K B2  
Philip Ervin - A2K MB50 GM

Guillermo Heredia - A2000 1799  
Luke Jackson - A2000 ASO  
AJ Minter - A2000 D33  
Kyle Muller - A2K D33  
Dansby Swanson - A2000 1787

### CLEVELAND

Aaron Civale - A2000 B2  
Mason Hickman - A2000 D33  
Nolan Jones - A2K 1795  
Zach Plesac - A2000 ASO  
Cal Quantrill - A2000 ASO

Harold Ramirez - A2K 1799  
Amed Rosario - A2000 1787  
Eddie Rosario - A2K 1799  
Trevor Stephan - A2K B2

### LOS ANGELES (NL)

Austin Barnes - A2000 1790  
Mookie Betts - ASK MB50 GM  
Gerardo Carrillo - A2000 B125  
Andre Jackson - A2K B2  
Joe Kelly - A2K B2  
Clayton Kershaw - A2000 CK22 GM

Corey Knebel - A2K B2  
Gavin Lux - A2K DP15 GM  
Zach McKinstry - A2000 PPO5  
Max Muncy - A2K 1613  
Zach Reks - A2000 1799  
Alex Vesia - A2000 B2

### NEW YORK (NL)

Brett Baty - A2K 1721  
Dellin Betances - A2000 XLC  
Carlos Carrasco - A2000 B125  
Michael Conforto - A2K 1799  
Pete Crow-Armstrong - A2000 Y  
JD Davis - A2000 1781  
Jered Eickhoff - A2K B2

Aaron Loup - A2K D33  
Joey Lucchesi - A2000 HG12  
Seth Lugo - A2K B2  
Ronny Mauricio - A2K 1786  
Jose Peraza - A2000 1787  
Jonathan Villar - A2000 1788  
Dominic Smith - A2K 1775

### SEATTLE

JP Crawford - A2000 1787  
Zach DeLoach - A2K 1799  
Jarred Kelenic - A2000 1799  
Shed Long - A2000 1786

Kenyan Middleton - A2000 B125  
Dylan Moore - A2K 1787  
Justus Sheffield - A2000 XLC  
Tom Murphy - A2000 1790

### FASTPITCH

Monica Abbot - A2000 MA14 GM  
Ali Aguilar - A2K 1787  
Valerie Arioto - A2000 MC24  
Kelly Barnhill - A2000 V125  
Amanda Chidester - A2000 FPCM  
Amanda Fama - A2000 1786  
Courtney Gano - A2000 FPH12

Aubree Munro - A2000 AM1  
Aleshia Ocasio - A2000 V125  
Cat Osterman - A2000 P12  
Sierra Romero - A2000 SR32 GM  
Delaney Spaulding - A2000 FPH12  
Kelsey Stewart - A2000 KS7 GM  
Anissa Urtez - A2000 PPO5

### BALTIMORE

Jahmai Jones - A2000 1787  
Heston Kjerstad - A2000 1799  
Rio Ruiz - A2000 1786

Anthony Santander - A2000 1799  
Jordan Westburg - A2K 1787

### COLORADO

Daniel Bard - A2000 D33  
Ben Boden - A2K D33  
Phillip Diehl - A2000 HG12  
Lucas Gilbreath - A2000 B2  
Mychal Givens - A2K D33  
Garrett Hampson - A2000 1799

Ryan McMahon - A2000 EL3  
Elehuris Montero - A2000 1787  
Ryan Rolison - A2000 D33  
Antonio Senzatela - A2000 CK22  
Kyle Freeland - A2000 D33

### MIAMI

Jesus Aguilar - A2000 2800  
Brian Anderson - A2K 1795SS  
Anthony Bass - A2K B2  
JJ Bleday - A2K 1775

Garrett Cooper - A2000 2800  
Jose Devers - A2000 1786  
Miguel Rojas - A2000 1786

### BOSTON

Christian Arroyo - A2000 1716  
Matt Barnes - A2K B2  
Franchy Cordero - A2000 1799  
Rafael Devers - A2000 DW5SS  
Nathan Eovaldi - A2K B2  
Marwin Gonzalez - A2000 1799  
JD Martinez - A2000 1799

Adam Ottavino - A2000 B125  
Kevin Plawecki - A2000 M1  
Hudson Potts - A2K DW5  
Eduardo Rodriguez - A2000 B125  
Marcus Wilson - A2000 1799  
Connor Wong - A2000 1790

### DETROIT

Matt Boyd - A2000 B125  
Miguel Cabrera - A2000 MC24 GM  
Willi Castro - A2000 1790  
Niko Goodrum - A2K 1787  
Alex Lange - A2K B2

Daniel Norris - A2K DW5  
Wilson Ramos - A2000 1790  
Zack Short - A2000 1786  
Christin Stewart - A2K 1775  
Spencer Torkelson - A2K 1795SS

### MILWAUKEE

Ray Black - A2K D33  
Lorenzo Cain - A2000 1799  
Derek Fisher - A2K 1799  
Avisail Garcia - A2K 179

Luke Maile - A2K M1D  
Mark Mathias - A2K 1787  
Billy McKinney - A2K 1799  
Justin Topa - A2000 B2

### PHILADELPHIA

Sam Coonrod - A2K CJW  
Spencer Howard - A2000 D33  
Damon Jones - A2K CJW  
Mauricio Llovera - A2K D33

Nick Maton - A2000 1786  
Mickey Moniak - A2000 1799  
Aaron Nola - A2000 CK22  
Roman Quinn - A2000 Y

### TAMPA BAY

Randy Arozarena - A2K MB50  
Oliver Drake - A2000 B125  
Rich Hill - A2000 B125  
Collin McHugh - A2000 XL  
Kevin Padlo - A2K 1721

Brett Phillips - A2000 1799  
Colin Poche - A2K 1795  
Jeffrey Springs - A2000 B125  
Joey Wendle - A2K 1721/A2000 G5  
Alika Williams - A2K 1786

### PITTSBURGH

David Bednar - A2K D33  
Dustin Fowler - A2K 1799  
Geoff Hartlieb - A2000 ASO

Ke'Bryan Hayes - A2000 KBH13 GM  
Brian Reynolds - A2K 1799

### TEXAS

Willie Calhoun - A2K MB20  
Brett de Geus - A2K B2  
Jonah Heim - A2000 MN25  
Jonathan Hernandez - A2K B2

Josh Jung - A2K G5  
Joe Palumbo - A2000 B2  
Anderson Tejeda - A2K 1786/1787

### CHICAGO (AL)

Jose Abreu - A2K JAB79 GM  
Tim Anderson - A2000 TA7 GM  
Aaron Bummer - A2000 D33  
Dylan Cease - A2000 ASO  
Yoelqui Cespedes - A2K MB50 GM  
Zack Collins - A2K 1790  
Adam Engel - A2000 1799

Jace Fry - A2000 CK22  
Leury Garcia - A2K 1799  
Eloy Jimenez - A2000 1775  
Lance Lynn - A2000 KP92  
Nick Madrigal - A2000 1786  
Danny Mendick - A2000 1786  
Gavin Sheets - A2000 2820

### HOUSTON

Bryan Abreu - A2K B2  
Jose Altuve - A2000 JA27 GM  
Yordan Alvarez - A2K 1775  
Brandon Bielak - A2K B2  
Jason Castro - A2000 1790

Carlos Correa - A2000 CC1 GM  
Yuli Gurriel - A2K 2800  
Taylor Jones - A2000 1799  
Myles Straw - A2000 1799  
Framber Valdez - A2000 B2

### MINNESOTA

Luis Arraez - A2K 1788  
Travis Blankenhorn - A2K 1721  
Keon Broxton - A2K KP92  
Jake Cave - A2K KP92  
Gilberto Celestino - A2K MB50 GM  
Dakota Chalmers - A2K D33  
Alex Colome - A2K B2

Mitch Garver - A2000 M1  
Nick Gordon - A2K 1786  
Alex Kirilloff - A2000 JH32  
Royce Lewis - A2000 1786  
Jorge Polanco - A2000 1787  
JT Riddle - A2K 1787

### SAN DIEGO

Austin Adams - A2K D33  
Mike Clevinger - A2000 B2  
Jake Cronenworth - A2K 1786  
Tim Hill - A2K CJW  
Mark Melancon - A2000 CJW

Jurickson Profar - A2K MB50GM  
Craig Stammen - A2000 ASO  
Matt Strahm - A2000 D33  
Taylor Williams - A2000 A12

### TORONTO

Phil Clarke - A2000 CM33  
Santiago Espinal - A2000 X2  
Vladimir Guerrero Jr. - A2000 V627/A2000 1617  
Lourdes Gurriel Jr. - A2000 Y  
Teoscar Hernandez - A2000 Y/A2000 1799

Austin Martin - A2000 G5  
Robbie Ray - A2000 D33/HG12  
Tanner Roark - A2K ASO  
Hyun-Jin Ryu - A2K RYU99  
Ross Stripling - A2000 B125

### CHICAGO (NL)

Cory Abbott - A2000 D33  
Brennen Davis - A2000 1799  
Matt Duffy - A2000 DW5  
Nico Hoerner - A2000 1786  
Jonathan Holder - A2000 B125  
Ed Howard - A2K 1786

Brailyn Marquez - A2000 B2  
Tyson Miller - A2K B2  
Alec Mills - A2K D33  
James Norwood - A2000 B125  
Kyle Ryan - A2000 ASO  
Duane Underwood - A2000 CK22

### KANSAS CITY

Hanser Alberto - A2000 1785  
Andrew Benintendi - A2000 KP92  
Ronald Boloños - A2000 B125  
Kris Bubic - A2000 B2  
Hunter Dozier - A2K 1721  
Kelvin Gutierrez - A2000 DW5  
Greg Holland - A2000 CK22 GM

Ryan McBroom - A2K 1613  
Ryan O'Hearn - A2K 2800  
Carlos Santana - A2K 2800  
Jorge Soler - A2000 1799  
Josh Staumont - A2K D33  
Bobby Witt Jr - A2K G4

### NEW YORK (AL)

Miguel Andujar - A2K DW5  
Zack Britton - A2000 B2  
Aroldis Chapman - A2K CJW  
Thairo Estrada - A2K 1786  
Clint Frazer - A2000 KP92

Darren O'Day - A2K B2  
Jameson Taillon - A2K ASO  
Mike Tauchman - A2000 KP92  
Adam Warren - A2000 ASO  
C. Austin Wells - A2000 1791

### SAN FRANCISCO

Tyler Biede - A2000 B125  
Brandon Belt - A2K 2802  
Tommy La Stella - A2000 1789

Evan Longoria - A2000 EL3  
Conner Menez - A2000 B125  
LaMonte Wade Jr - A2000 KP92

### WASHINGTON

Josh Bell - A2K JAB79  
Ben Braymer - A2K B2  
Starlin Castro - A2000 1786  
Patrick Corbin - A2000 B2  
Luis Garcia - A2000 1786/1716  
Josh Harrison - A2K 1786

Carter Kieboom - A2K 1787  
Jon Lester - A2000 JL34/B125  
Victor Robles - A2000 1799  
Kyle Schwarber - A2K 1799  
Juan Soto - A2K JS22/1799

# PRO STOCK® GLOVES

Pro Stock® patterns used by the pros. The best ball glove materials out there. Glove craftsmen devoted to hand crafting the best gloves in the game. It's no surprise that big leaguers choose Wilson® to get them through a 162-game season. The same patterns, materials and craftsmanship go into every Wilson Pro Stock glove whether it's made for play on the game's biggest stage or your local diamonds. For the pros. By the pros.

SIZE	PATTERN	A2K®	A2K® SUPERSKIN™	A2K® SPIN CONTROL	A2000®	A2000® SUPERSKIN™	A2000® PEDROIA FIT™	2000® SPIN CONTROL
<b>INFIELD</b>								
11"	PFX2							
11.25"	PF88							
11.5"	OA1 GM							
11.5"	DP15							
11.5"	1716							
11.5"	1786							
11.5"	LTM86							
11.5"	TA7GM							
11.5"	PP05							
11.75"	1787							
11.75"	KBH13GM							
11.75"	1975							
11.75"	1785							
12"	1912							

**NEW** NEW FOR 2022 **GM** GAME MODEL

SIZE	PATTERN	A2K®	A2K® SUPERSKIN™	A2K® SPIN CONTROL	A2000®	A2000® SUPERSKIN™	A2000® PEDROIA FIT™	2000® SPIN CONTROL
<b>1ST BASE</b>								
12.5"	1620							
12.5"	JAB79							
<b>OUTFIELD</b>								
12.25"	PF92							
12.5"	MB50 GM							
12.75"	1799							
12.75"	OT7							
12.75"	1775							
12.75"	1800							
<b>PITCHER</b>								
11.75"	CK22 GM							
11.75"	D33							
12"	B2							
<b>CATCHER</b>								
33"	PF33							
33"	CM33							
33.5"	M1D							

GET A GRIP WITH

# SPIN CONTROL<sup>®</sup>

TECHNOLOGY

A **PATENTED** dimpled texture in our iconic Pro Stock<sup>®</sup> Leather designed to increase friction between the ball and your glove.

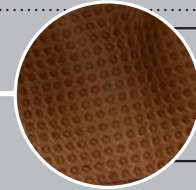

IT'S THE SAME PRO STOCK LEATHER YOU KNOW & LOVE IN A WILSON GLOVE ...



WITH DIMPLED TEXTURE ADDED TO THE PALM, FINGERS AND OCCASIONALLY THE WEB.

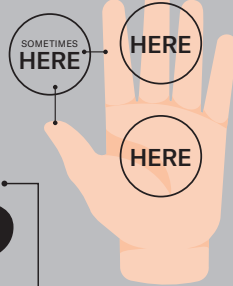

IN ADDITION TO OUR ON-FIELD WORK WITH BALLPLAYERS, WE'VE COLLABORATED WITH OUR PRO STOCK<sup>®</sup> LEATHER TANNERY AND AERODYNAMICS EXPERTS TO CREATE A2000<sup>®</sup> AND A2K<sup>®</sup> GLOVES THAT HELP PLAYERS CONTROL THE BALL WHILE MAKING PLAYS FASTER AND MORE CONSISTENTLY THAN EVER BEFORE.



## WHAT DOES IT ALL MEAN?

Spin Control Technology<sup>®</sup> is designed to help you corral the ball and cleanly transfer it to your throwing hand so you can deliver it to your target with speed and precision.



## WHAT MAKES THE SUPERSKIN<sup>™</sup> SO SUPER?

SuperSkin<sup>™</sup> is a carefully tested and refined microfiber material, perfected to deliver ultimate durability at the lightest weight possible. It repels moisture to keep your glove from getting bogged down by the weight of rain or wet grass. For years, other manufacturers have tried to create their own version of SuperSkin<sup>™</sup> using ballistic nylon, molded materials and more — only to come up short time after time.

**2X STRONGER**

**50% LIGHTER**

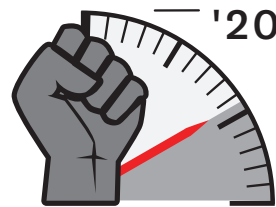

8 COLORS AVAILABLE

LIGHTER WEIGHT ENHANCES PERFORMANCE



& INTRODUCING SUPERSNAKESKIN

1999 **2** PRO PLAYERS USING SUPERSKIN  
PRESENT **>50%**

## TIME TESTED

Since the 1990s, countless pros have sworn by their SuperSkin<sup>™</sup> gloves. Craig Counsell, who played 16 seasons in the Major Leagues, is just one example. Aso built him one of the first SuperSkin<sup>™</sup> gloves in 1999, and he used it until his retirement in 2011. Craig Counsell loved the glove so much, Aso said.



WILSON BALL GLOVE MASTER CRAFTSMAN

# SHIGEAKI ASO

If you love what you do, you'll never work a day in your life. Few individuals in the world embody that expression as much as Aso, who has dedicated his life to the game he loves.

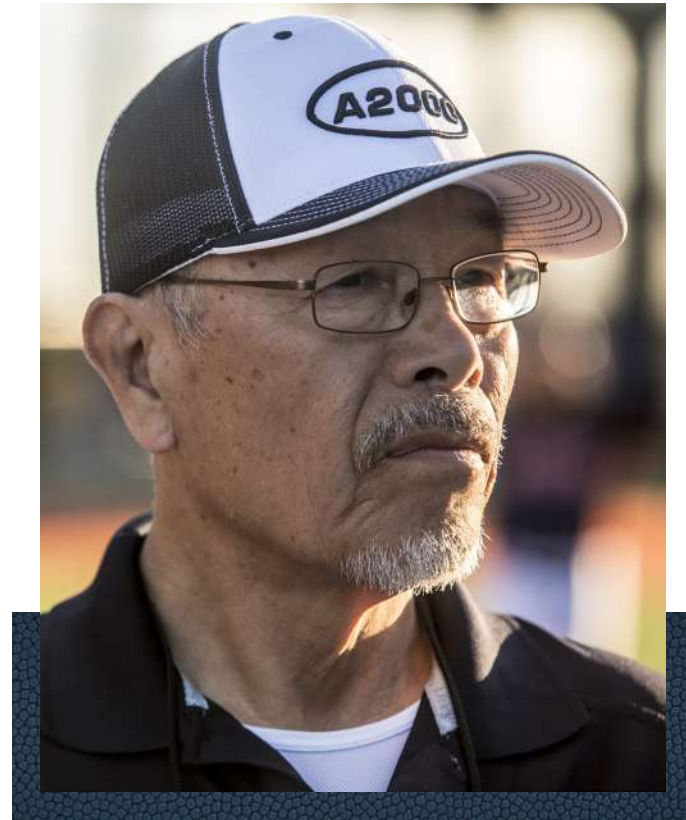

THAT'S MY GOAL. I DON'T WANT A PLAYER TO THINK ABOUT THEIR GLOVE AT ALL. HIS SMILE IS MY SMILE. IF HE SMILES, I CAN SMILE.

- Shigeaki Aso

Wilson Baseball master Craftsman Shigeaki Aso has revolutionized the game for generations of players. His initial impact on the highest level of the game came in 1986 when he visited pro camps for the first time. With his decades of industry experience working with hides and leather quality control, he immediately noticed how common infield patterns featured long pinky and thumb stalls that were cumbersome to players.

He gathered feedback from as many players as he could find. One year later, he returned with what is, to this day, the most popular Wilson pattern — the A2000<sup>®</sup> 1786. From there, Aso developed the A2000<sup>®</sup> 1787 and A2000<sup>®</sup> 1788, launching a legendary journey of creating ball gloves.

Aso's initial iconic glove patterns were just the first innovations to come from his relationships with players. Aso has put in countless hours with some of the best to ever set foot on the field. Those collaborative efforts continue to this day with elite talents like Mookie Betts, Tim Anderson and Clayton Kershaw.

Aso credits the still-present language barrier between himself and big leaguers for his detailed understanding of what players are looking for in their gloves.

"I'm not a very good English speaker, which is why I ask questions again and again to players," Aso said. "They explain very honestly what they want. If I spoke English better, would they explain things so well to me? But they make sure to explain everything well because that means they'll get a great glove."

These conversations lead to the constant evolution of Wilson ball gloves, from the groundbreaking development of SuperSkin<sup>™</sup> to more recent designs like Flat Finger Binding and Fastpitch-specific patterns and features. All these innovations share one common goal — ensuring that a player never has to think about their glove. It serves as an extension of the athlete, not an accessory.

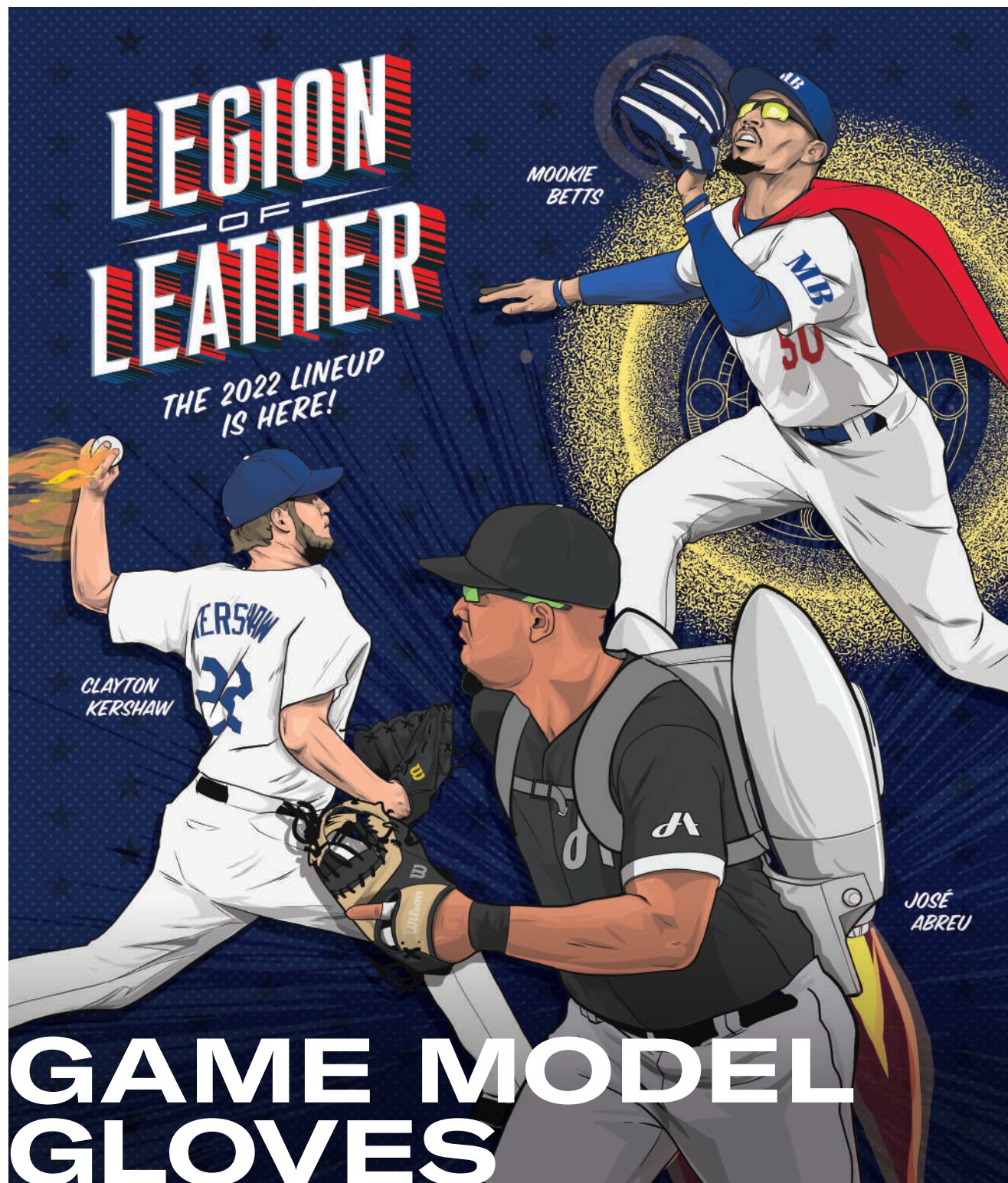

## PURSuing PERFECTION

Wilson® Game Model gloves aren't just worn by professionals. They're designed by them. Wilson Ball Glove Master Craftsman Shigeaki Aso sits down with select Advisory Staff members — either in person or on a video call — to craft a Game Model glove designed specifically for their play.

Aso-san's relentless passion drives his pursuit of the perfect glove. He collaborates with players to receive detailed feedback and ensure each glove is built to work for the player's game. Every glove has unique features, from the laces to the webbing and even the materials used, culminating in an innovative line of Wilson Game Model gloves.

## A2K® GAME MODEL GLOVES



GM

### OZZIE ALBIES

Fortune favors the bold, the risk-takers, the ones who pour their heart and soul into their craft. Atlanta second baseman Ozzie Albies and his custom A2K OA1 GM, featuring Red Pro Stock® Select Leather and Bold Wilson Yellow logos, are ready to reign supreme with a revamped squad this season.

INFIELD 11.5"

ARTICLE

WBW100234115

MSRP

\$379.95

#### OZZIE'S GLOVE FEATURES

- H-Web
- Red Pro Stock® Select Leather with Yellow Accents
- Game Model of Ozzie Albies—A2K OA1 GM



NEW

GM

### MOOKIE BETTS

Ready to rob homers and steal the spotlight, the 2022 A2K® MB50 GM was meticulously designed for Mookie Betts. This 12.5" model with a narrower heel offers more control, and the Navy Blue Pro Stock® Select Leather and Royal Blue Dual Post Web can haul in any fly ball. Lightweight White and Matte Royal Blue SuperSkin™ reduces glove weight while improving durability.

OUTFIELD 12.5"

ARTICLE

WBW100471125

WBW100472125 [LHT]

MSRP

\$379.95

#### MOOKIE'S GLOVE FEATURES

- Dual Post Web
- Navy Pro Stock Select Leather with Red Accents
- White and Matte Royal Blue SuperSkin™
- Game Model of Mookie Betts – A2K MB50 GM



GM

### JOSÉ ABREU

A new era is dawning on the South Side. Chicago first baseman Jose Abreu is ready to lead his club this season with the all-new A2K® JAB79 GM, designed with Black SuperSnakeSkin, Blonde Pro Stock Leather, a one-of-a-kind personalized Single Post Web and revolutionary Spin Control Technology.

1ST BASE 12.5"

ARTICLE

WBW100233125

WBW100232125 [LHT]

MSRP

\$379.95

#### JOSÉ'S GLOVE FEATURES

- Single Post Web
- Black Spin Control® Palm with Black SuperSnakeSkin™ Back Blonde Accents
- Game Model of José Abreu—A2K JAB79 GM

## A2000® GAME MODEL GLOVES



NEW

GM

### TIM ANDERSON

Tim Anderson is always looking to bring some flair to his game on Chicago's South Side, and his new 2022 A2000® TA7 GM is here to make a statement on the field. Black and Grey SuperSnakeSkin™ reduces glove weight while enhancing durability and moisture resistance, and the reinforced H-Web helps to corral the ball all over the infield.

INFIELD 11.5"

ARTICLE

WBW100433115

MSRP

\$279.95

#### TIM'S GLOVE FEATURES

- Reinforced H-Web
- Black Pro Stock® Leather
- Black and Grey SuperSnakeSkin
- Game Model of Tim Anderson – A2000 TA7 GM



NEW

GM

### KE'BRYAN HAYES

Ke'Bryan Hayes and his 2022 A2000® KBH13 GM glove are ready to handle the hot corner in Pittsburgh. The Black SuperSnakeSkin™ back cuts glove weight while improving durability and moisture resistance. Built with Wilson's iconic H-Web, this 11.75" game model has the extra length third basemen prefer, and Flat Finger Binding allows you to comfortably keep a finger out for more control when making plays.

INFIELD 11.75"

ARTICLE

WBW1004321175

MSRP

\$279.95

#### KE'BRYAN'S GLOVE FEATURES

- H-Web
- Black Pro Stock® Leather with Blonde Accents
- Black SuperSnakeSkin
- Game Model of Ke'Bryan Hayes – A2000 KBH13 GM



GM

### CLAYTON KERSHAW

Perhaps the greatest pitcher of his generation, Clayton Kershaw continues to dominate. For every win, Cy Young Award and postseason appearance, the left-hander has donned the same clean, classic A2000 CK22 GM with Black Pro Stock and iconic gold logos.

PITCHER 11.75"

ARTICLE

WBW1002361175

WBW1002371175 [LHT]

MSRP

\$279.95

#### CLAYTON'S GLOVE FEATURES

- Closed Two-Piece Web
- Black Pro Stock® Leather with Gold Accents
- Game Model of Clayton Kershaw—A2000 CK22 GM

# A2K®

## THE LEGENDARY A2K

This isn't just any ball glove. It's the best ball glove in the world. The 2022 A2K® glove lineup is designed for the game's elite players, using the most premium materials and technologies available in modern ball gloves. Combinations of Wilson's flawless Pro Stock® Select leather, SnakeSkin stylings and Wilson's Bold Logo packages come together in each glove to create unforgettable, never-before-seen looks. Every A2K® is built to last with triple-sorted hide, and the legendary Double Palm™ construction gives you a more stable pocket, helping your glove hold its shape longer than any other glove on the market today.

**1.**

**PRO STOCK® SELECT LEATHER:**  
The top five percent of Pro Stock® hides are chosen by a triple-sorting process for consistency and flawlessness. The result is an incomparable break-in and long-lasting shape.

**2.**

**ROLLED DUAL WELTING™:**  
Thin Strips of Pro Stock® Select leather are skived thin and rolled to provide long-lasting shape and an unparalleled break-in.

**3.**

**DOUBLE PALM CONSTRUCTION:**  
A thin, perfectly shaped piece of leather placed between the palm liner and outer shell, giving you what matters most: maximum pocket stability.

**4.**

**THREE TIMES MORE SHAPING:**  
Our expert craftsmen spend three times longer pounding and shaping the A2K® by hand, helping reduce break-in time.



**SS**

**INFIELD 11.5"**

ARTICLE  
WBW100059115  
MSRP  
\$379.95

- A2K 1786SS
- H-Web
- Black SuperSkin™/Black SnakeSkin Pro Stock® Select Leather

**NEW**  
**SC**

**INFIELD 11.5"**

ARTICLE  
WBW100409115  
MSRP  
\$379.95

- A2K 1786SC
- H-Web
- Blonde/Gunmetal Pro Stock® Select Leather
- Spin Control® Dimpled Palm

**GM**

**INFIELD 11.5"**

ARTICLE  
WBW100234115  
MSRP  
\$379.95

- A2K OA1 GM
- H-Web
- Red Pro Stock® Select Leather with Yellow Accents
- Game Model of Ozzie Albies

**NEW**  
**SC**

**INFIELD 11.75"**

ARTICLE  
WBW1004101175  
MSRP  
\$379.95

- A2K 1787SC
- H-Web
- Brick Red/Black Pro Stock® Select Leather
- Spin Control® Dimpled Palm

**SS**

**INFIELD 11.75"**

ARTICLE  
WBW1000611175  
MSRP  
\$379.95

- A2K 1787SS
- H-Web
- Black SuperSkin™/Black SnakeSkin Pro Stock® Select Leather

**SS**

**PITCHER 11.75"**

ARTICLE  
WBW1000631175  
WBW1000641175 (LHT)  
MSRP  
\$379.95

- A2K D33
- Closed Pro Laced Web
- Black SuperSkin™/Black SnakeSkin Pro Stock® Select Leather

**NEW**  
**SC**

**OUTFIELD 12.75"**

ARTICLE  
WBW1004131275  
WBW1004141275 (LHT)  
MSRP  
\$379.95

- A2K 1775SC
- Single Post Hourglass
- Grey/Balk Pro Stock® Select Leather
- Spin Control® Dimpled Palm

**SS**

**OUTFIELD 12.75"**

ARTICLE  
WBW1000691275  
WBW1000701275 (LHT)  
MSRP  
\$379.95

- A2K 1799SS
- Dual Post Web
- Black SuperSkin™/Saddle Tan SnakeSkin Pro Stock® Select Leather

**NEW**  
**GM**

**OUTFIELD 12.5"**

ARTICLE  
WBW100471125  
WBW100472125 (LHT)  
MSRP  
\$379.95

- A2K MB50 GM
- Dual Post Web
- White/Matte Royal Blue SnakeSkin™/Navy Pro Stock® Select Leather with Red Accents
- Game Model of Mookie Betts

**CATCHER 33.5"**

ARTICLE  
WBW100071335  
MSRP  
\$379.95

- A2K M1D
- Half-Moon Web
- Black SnakeSkin™/Saddle Tan Pro Stock® Select Leather

**GM**

**1ST BASE 12.5"**

ARTICLE  
WBW100233125  
WBW100232125 (LHT)  
MSRP  
\$379.95

- A2K JAB79 GM
- Single Post Web
- Black Spin Control with Black Super SnakeSkin™ Back with Blonde Accents
- Game Model of Jose Abreu

# A2000®

## THE PREMIER GLOVE

A2000® gloves continue to evolve with the game. Durable Pro Stock® Leather offers a consistent feel and perfect break in. Comfort Pro™ Lining forms to your hand over time, pairing with our Comfort Sleeve wrist binding for the best feeling A2000 ever. Flat Finger Binding allows you to comfortably play with a finger out for improved control, and the Bold Logo package stands out on the diamond. The 2022 A2000® lineup also includes patterns built with Wilson's most innovative technologies, including the lightweight and durable SuperSkin™ and Spin Control Technology®— designed to increase friction between the ball and your glove, and Pedroia Fit™ — the perfect fit for players with smaller hands.

**1.**

**PRO STOCK® LEATHER:**

Wilson's iconic Pro Stock® Leather is preferred for its rugged durability and unmatched feel.

**2.**

**COMFORT PRO™ LINING:**

Comfort Pro™ Lining, featuring ProLux™ Leather, has a richer, softer feel that molds to your hand over time.

**3.**

**FLAT FINGER BINDING:**

Flat Finger Binding allows you to comfortably play with a finger out, giving players more control over their glove.

**4.**

**ROLLED DUAL WELTING™:**

Rolled Dual Welting™ is integrated into the liner of Wilson gloves, offering better support and helping your glove maintain its shape over time.



NEW



**INFIELD** 11.5"  
ARTICLE  
WBW100389115  
MSRP  
\$279.95

- A2000 1716
- H-Web
- Black/Copper Pro Stock® Leather

NEW



**INFIELD** 11.5"  
ARTICLE  
WBW100390115  
MSRP  
\$279.95

- A2000 1786
- H-Web
- Blonde/Saddle Tan Pro Stock® Leather

NEW



**INFIELD** 11.5"  
ARTICLE  
WBW100391115  
MSRP  
\$279.95

- A2000 LTM86
- H-Web
- Autism Speaks® Blue Pro Stock® Leather

NEW



**INFIELD** 11.5"  
ARTICLE  
WBW100087115  
MSRP  
\$279.95

- A2000 PP05
- Dual Post Web
- Copper/Blonde Pro Stock® Leather



**INFIELD** 11.75"  
ARTICLE  
WBW1000881175  
MSRP  
\$279.95

- A2000 1975
- H-Web
- Black and Copper Pro Stock® Leather

GM



**PITCHER** 11.75"  
ARTICLE  
WBW1002361175  
WBW1002371175 (LHT)  
MSRP  
\$279.95

- A2000 CK22GM
- Closed Two-Piece Web
- Black Pro Stock® Leather with Gold Accents
- Game Model of Clayton Kershaw

NEW



**PITCHER** 11.75"  
ARTICLE  
WBW1003921175  
WBW1003931175 (LHT)  
MSRP  
\$279.95

- A2000 D33
- Closed Pro Laced Web
- Vintage Tan/Copper Pro Stock® Leather

NEW



**OUTFIELD** 12.75"  
ARTICLE  
WBW1003941275  
WBW1003951275 (LHT)  
MSRP  
\$279.95

- A2000 1799
- Dual Post Web
- Blonde/Saddle Tan Pro Stock® Leather



# A2000<sup>®</sup>

## SUPERSKIN<sup>™</sup>

The A2000<sup>®</sup> SuperSkin<sup>™</sup> glove series is the ultimate utility player of the Wilson lineup. Featuring a versatile combination of Pro Stock<sup>®</sup> leather and microfiber SuperSkin<sup>™</sup> material, these gloves are stronger, lighter and easier to break in than the all-leather A2000<sup>®</sup>.



**SUPERSKIN<sup>™</sup>:**  
Twice as strong as traditional Pro Stock<sup>®</sup> Leather and only half the weight.

**REPELS MOISTURE:**  
Moisture resistant to extend longevity of the glove and prevent it from getting bogged down by the weight of rain or wet grass.

**STRATEGIC DESIGN:**  
Leather and SuperSkin<sup>™</sup> is strategically placed to benefit players. SuperSkin<sup>™</sup> material on the back of the hand cuts glove weight and is easier to clean than traditional leather.



# A2000<sup>®</sup>

## PEDROIA FIT<sup>™</sup>

Find the glove to fit your game. Perfect for players with smaller hands, Wilson gloves with Pedroia Fit<sup>™</sup> are designed to create a secure fit. Pedroia Fit<sup>™</sup>, available in several Pro Stock<sup>®</sup> glove models, features shorter, narrower finger stalls and a smaller hand opening.



**PERFECT FIT:**  
Designed to create a perfect fit for players with smaller hands.

**INNOVATIVE DESIGN:**  
Gloves feature a smaller hand opening and shorter, narrower finger stalls, alterations designed to create a secure fit for players with smaller hands

**PRO STOCK<sup>®</sup> LEATHER:**  
Pedroia Fit<sup>™</sup> is available in a full line of Pro Stock<sup>®</sup> models, giving you plenty of options to find the perfect glove.

**NEW**  
**GM**



**INFIELD** 11.5"  
ARTICLE  
WBW100433115  
MSRP  
\$279.95

- A2000 TA7 GM
- Reinforced H-Web
- Black/Grey Super SnakeSkin Pro Stock<sup>®</sup> Select Leather
- Game Model of Tim Anderson

**NEW**  
**SS**



**INFIELD** 11.5"  
ARTICLE  
WBW100396115  
MSRP  
\$279.95

- A2000 1786SS
- H-Web
- Black SuperSkin<sup>™</sup>/Grey Pro Stock<sup>®</sup> Leather

**NEW**  
**SS**  
**PF**



**INFIELD** 11"  
ARTICLE  
WBW10039711  
MSRP  
\$279.95

- A2000 PFX2 SS
- X2 Web
- Black SuperSkin<sup>™</sup>/Black Pro Stock<sup>®</sup> Leather

**SS**  
**PF**



**INFIELD** 11.25"  
ARTICLE  
WBW1001071125  
MSRP  
\$279.95

- A2000 1788SS
- H-Web
- Black SuperSkin<sup>™</sup>/Blonde/Red Pro Stock<sup>®</sup> Leather

**NEW**  
**GM**



**INFIELD** 11.75"  
ARTICLE  
WBW1004321175  
MSRP  
\$279.95

- A2000 KBH13 A2000 GM
- H-Web
- Black Super SnakeSkin/Black Pro Stock<sup>®</sup> Select Leather with Blonde Accents
- Game Model of Ke'Bryan Hayes

**SS**



**INFIELD** 12"  
ARTICLE  
WBW10009912  
MSRP  
\$279.95

- A2000 1912SS
- Cross Web w/ 3X Center Lace
- Grey SuperSkin<sup>™</sup>/Grey Pro Stock<sup>®</sup> Leather

**PF**



**INFIELD** 11.5"  
ARTICLE  
WBW100108115  
MSRP  
\$279.95

- A2000 DP15
- H-Web
- Saddle Tan Pro Stock<sup>®</sup> Leather

**NEW**  
**SS**  
**PF**  
**SC**



**INFIELD** 11.5"  
ARTICLE  
WBW100399115  
MSRP  
\$279.95

- A2000 DP15SS
- H-Web
- Black SuperSkin<sup>™</sup> Pro Stock<sup>®</sup> Leather
- Spin Control<sup>®</sup> Dimpled Palm

**SS**



**PITCHER** 12"  
ARTICLE  
WBW10010012  
WBW10010112 (LHT)  
MSRP  
\$279.95

- A2000 B2SS
- Closed Two-Piece Web
- Black SuperSkin<sup>™</sup>/Black/Blonde Pro Stock<sup>®</sup> Leather

**SS**



**OUTFIELD** 12.75"  
ARTICLE  
WBW1001021275  
WBW1001031275 (LHT)  
MSRP  
\$279.95

- A2000 1800SS
- Single Post Web w/ Baseball Stitch
- Black SuperSkin<sup>™</sup>/Black/Blonde Pro Stock<sup>®</sup> Leather

**SS**  
**PF**



**OUTFIELD** 12.25"  
ARTICLE  
WBW1001101225  
WBW1001111225 (LHT)  
MSRP  
\$279.95

- A2000 FP92SS
- Pro Laced T-Web w/ Baseball Stitch
- Black SuperSkin<sup>™</sup>/Grey Pro Stock<sup>®</sup> Leather



# A2000®

SPIN CONTROL TECHNOLOGY®

Wilson A2000® ball gloves with Spin Control Technology® feature a dimpled pattern in the same Pro Stock® Leather that you know and love. This textured pattern in the palm of your A2000® helps reduce the spin rate of the ball by rapidly increasing friction between the ball and the glove at the moment of contact.



**DIMPLED TEXTURE:**  
A patented dimpled texture added to our iconic Pro Stock® leather.

**INCREASED FRICTION:**  
The textured pattern is designed to increase the amount of friction between the ball and your glove, helping you to handle short hops in the field.

**ENHANCED CONTROL:**  
Spin Control Technology™ gives you more control to corral scorching line drives and hard grounders before making the transfer and hitting your target.



## A2000® MITTS



**CATCHER** 33"  
ARTICLE  
WBW10011533  
MSRP  
\$279.95

- A2000 CM33
- Half-Moon Web
- Blonde/Black Pro Stock® Leather



**CATCHER** 33"  
ARTICLE  
WBW10016233  
MSRP  
\$279.95

- A2000 PF33
- Half-Moon Web
- Black Superskin™/Coal Pro Stock® Leather



**CATCHER** 33.5"  
ARTICLE  
WBW100401335  
MSRP  
\$279.95

- A2000 M1D
- Half-Moon Web
- Black Superskin™/Black Pro Stock® Leather



**1ST BASE** 12.5"  
ARTICLE  
WBW100119125  
WBW100120125 [LHT]  
MSRP  
\$279.95

- A2000 1620SS
- Single Post Web
- Grey Superskin™/Black Pro Stock® Leather



**INFIELD** 11.5"  
ARTICLE  
WBW100153115  
MSRP  
\$279.95

- A2000 1786SC
- H-Web
- Blonde/Saddle Tan Pro Stock® Leather
- Spin Control® Dimpled Palm



**INFIELD** 11.75"  
ARTICLE  
WBW1004001175  
MSRP  
\$279.95

- A2000 1787SS
- H-Web
- Blonde/Saddle Tan Pro Stock® Leather
- Spin Control® Dimpled Palm



**INFIELD** 11.75"  
ARTICLE  
WBW1001541175  
MSRP  
\$279.95

- A2000 75SS
- H-Web
- Grey Superskin™
- Spin Control® Dimpled Palm



**OUTFIELD** 12.75"  
ARTICLE  
WBW1001561275  
WBW1001581275 [LHT]  
MSRP  
\$279.95

- A2000 OT6
- 6-Finger Web
- Black Superskin™ Pro Stock® Leather
- Spin Control® Dimpled Palm



**1ST BASE** 12.5"  
ARTICLE  
WBW100123125  
WBW100124125 [LHT]  
MSRP  
\$279.95

- A2000 1620SS
- Single Post Web
- Black Superskin™
- Spin Control® Dimpled Palm



# A1000®

## BROKEN IN & READY TO GO

Grounders, line drives and fly balls don't stand a chance against A1000® ball gloves, models crafted with soft yet sturdy leather that is game-ready on day one. There's no long winter break-in or sore knuckles from punching the leather. The A1000® is ready to make an immediate impact whenever you are.



### DOUBLE PALM CONSTRUCTION (FRONT SIDE):

A thin, perfectly shaped piece of leather placed between the palm liner and outer shell, giving you what matters most: maximum pocket stability.

### FULL LEATHER CONSTRUCTION:

Leather shell, laces and pal liner. These ball gloves expertly break in and conform to your hand.

### LOW PROFILE HEEL (FRONT SIDE):

Gives more flexibility, opens up the palm and pocket and makes it more forgiving on bad hops.

### OUTLINED LOGO PACKAGE:

Outfitted with the new outline logo package, the Wilson A1000 ball gloves stand out on the diamond.



# A700

## GAME READY LEATHER

The A700™ line of Wilson gloves are the epitome of game ready. Designed with soft, full grain cowhide leather, A700™ ball gloves give you the perfect feel without the added bulk.



**FULL GRAIN LEATHER:**  
The perfectly soft feel without added weight.

**NO BREAK-IN:**  
Game ready on day one.

**DRAWSTRING CLOSURE:**  
Make in-game glove adjustments on the fly and ensure a secure fit in the field. Pull the long rawhide lace to set your wrist closure into place for the perfect fit.



**NEW**  
**PF**  
**INFIELD** 11"  
ARTICLE  
WBW10013111  
MSRP  
\$139.95  
• X2 Web  
• Pedroia Fit™  
• Black/Red/Grey Full Grain Optima Leather



**NEW**  
**PF**  
**INFIELD** 11.5"  
ARTICLE  
WBW100132115  
WBW100133115 (LHT)  
MSRP  
\$139.95  
• H-Web  
• Pedroia Fit™  
• Black/Tropical Blue/Blonde Full Grain Optima Leather



**INFIELD** 11.25"  
ARTICLE  
WBW1001251125  
MSRP  
\$84.95  
• H-Web  
• Drawstring Wrist Closure  
• Black/Red/Royal Full Grain Leather



**NEW**  
**INFIELD** 11.5"  
ARTICLE  
WBW100126115  
MSRP  
\$84.95  
• H-Web  
• Drawstring Wrist Closure  
• Black/Red/Blonde Full Grain Leather



**NEW**  
**INFIELD** 11.5"  
ARTICLE  
WBW100134115  
MSRP  
\$139.95  
• H-Web  
• Grey/Black/Blonde Full Grain Optima Leather



**NEW**  
**INFIELD** 11.75"  
ARTICLE  
WBW1001351175  
MSRP  
\$139.95  
• H-Web  
• Grey/Blonde/Royal Full Grain Optima Leather



**NEW**  
**OUTFIELD** 12"  
ARTICLE  
WBW10012712  
WBW10012812 (LHT)  
MSRP  
\$84.95  
• Pro Laced T-Web  
• Drawstring Wrist Closure  
• Black/Red/White Full Grain Leather



**OUTFIELD** 12.5"  
ARTICLE  
WBW100129125  
WBW100130125 (LHT)  
MSRP  
\$84.95  
• Single Post 3 Bar  
• Drawstring Wrist Closure  
• Black/Blonde/White Full Grain Leather



**NEW**  
**INFIELD** 12"  
ARTICLE  
WBW10013612  
WBW10013712 (LHT)  
MSRP  
\$139.95  
• Single Post 3X Web  
• Black/Red/Blonde Full Grain Optima Leather



**NEW**  
**PF**  
**OUTFIELD** 12.25"  
ARTICLE  
WBW1004071225  
WBW1004081225 (LHT)  
MSRP  
\$139.95  
• Single Post 3 Bar w/ Lacing  
• Pedroia Fit™  
• Black/White/Red Full Grain Optima Leather



**NEW**  
**CATCHER** 32.5"  
ARTICLE  
WBW100429325  
MSRP  
\$89.95  
• Half Moon Web  
• Pedroia Fit™ w/ Velcro®  
• Black/Blonde/Red Full Grain Leather



**NEW**  
**OUTFIELD** 12.5"  
ARTICLE  
WBW100138125  
WBW100139125 (LHT)  
MSRP  
\$139.95  
• Dual Post Web  
• Drawstring Closure  
• Grey/Black/Blonde Full Grain Optima Leather



**NEW**  
**1ST BASE** 12.5"  
ARTICLE  
WBW100140125  
WBW100141125 (LHT)  
MSRP  
\$139.95  
• Single Post 3 Bar  
• Black/Grey/White Full Grain Optima Leather



**NEW**  
**CATCHER** 33"  
ARTICLE  
WBW10014233  
MSRP  
\$139.95  
• Half Moon Web  
• Black/Blonde/White Full Grain Optima Leather



# A500

FOR THE YOUNG SERIOUS PLAYER

The A500™ is the lightest all-leather glove on the market. The glove's top-grain leather provides a flexible, ready-to-play feel that performs without the extra weight of other leather gloves.



**TOP GRAIN LEATHER:**  
All the feel without the weight.

**REAL LEATHER LACES:**  
Tough and strong for maximum durability.

**DOUBLE PALM CONSTRUCTION (FRONT SIDE):**  
A thin, perfectly shaped piece of leather placed between the palm liner and outer shell, giving you what matters most: maximum pocket stability.



## A450®



**INFIELD 10.75"**  
ARTICLE  
WBW1001711075  
MSRP  
\$44.95

- H-Web
- New Quick-Fit Wrist
- Grey/Black/White



**INFIELD 11"**  
ARTICLE  
WBW10017211  
WBW10017311 (LHT)  
MSRP  
\$44.95

- Dual Post Web
- New Quick-Fit Wrist
- Blonde/Black/White



**INFIELD 11.5"**  
ARTICLE  
WBW100174115  
WBW100175115 (LHT)  
MSRP  
\$44.95

- H-Web
- New Quick-Fit Wrist
- Black/Blonde/Red



**OUTFIELD 12"**  
ARTICLE  
WBW10017612  
WBW10017712 (LHT)  
MSRP  
\$44.95

- Dual Post Web
- New Quick-Fit Wrist
- Black/Royal/Red

## A360®



**ALL POSITIONS 12"**  
ARTICLE  
WBW10018712  
WBW10018812 (LHT)  
MSRP  
\$39.95

- 2-Piece Web
- Grey/Black New CarbonLight™ Material
- Youth Pattern



**ALL POSITIONS 12.5"**  
ARTICLE  
WBW100189125  
WBW100246125 (LHT)  
MSRP  
\$39.95

- 2-Piece Closed Weave Web
- Grey/Black New CarbonLight™ Material
- Youth Pattern



**CATCHER 31.5"**  
ARTICLE  
WBW100190315  
WBW100191315 (LHT)  
MSRP  
\$44.95

- Half-Moon Web
- Grey/Black New CarbonLight™ Material
- Youth Pattern

## A200® EZ CATCH



**ALL POSITIONS 10"**  
ARTICLE  
WBW10045410  
MSRP  
\$21.95

- H-Web
- Designed w/ Smaller Hand Opening for Better Fit
- Newly Designed to Assist Young Players w/ Grounders/Pop Ups
- White/Black/Purple



**ALL POSITIONS 10"**  
ARTICLE  
WBW10045510  
MSRP  
\$21.95

- H-Web
- Designed w/ Smaller Hand Opening for Better Fit
- Newly Designed to Assist Young Players w/ Grounders/Pop Ups
- Black/Red



**ALL POSITIONS 10"**  
ARTICLE  
WBW10045610  
WBW10045710 (LHT)  
MSRP  
\$21.95

- H-Web
- Designed w/ Smaller Hand Opening for Better Fit
- Newly Designed to Assist Young Players w/ Grounders/Pop Ups
- Royal/Red/White



**ALL POSITIONS 10"**  
ARTICLE  
WTA02RB19AS  
MSRP  
\$21.95

- H-Web
- Grey/Sky Blue
- Smaller Hand Opening for a Snugger Fit
- Love The Moment



**ALL POSITIONS 10.5"**  
ARTICLE  
WBW100143105  
MSRP  
\$64.95

- X2 WEB
- Black/Blonde/Red
- Smaller Hand Opening for a Snugger Fit



**ALL POSITIONS 11"**  
ARTICLE  
WBW10014411  
WBW10014511 (LHT)  
MSRP  
\$64.95

- H-Web
- Black/Grey/Wilson Yellow
- Smaller Hand Opening for a Snugger Fit



**ALL POSITIONS 11.5"**  
ARTICLE  
WBW100148115  
WBW100147115 (LHT)  
MSRP  
\$64.95

- H-Web
- Copper/Black/Wilson Yellow
- Smaller Hand Opening for a Snugger Fit



**ALL POSITIONS 12"**  
ARTICLE  
WBW10015512  
WBW10015712 (LHT)  
MSRP  
\$64.95

- Dual Post Web
- Copper/Blonde
- Smaller Hand Opening for a Snugger Fit



**ALL POSITIONS 12.5"**  
ARTICLE  
WBW100159125  
WBW100160125 (LHT)  
MSRP  
\$64.95

- Single Post Web
- Black/Grey/Blonde
- Smaller Hand Opening for a Snugger Fit



**CATCHER 32"**  
ARTICLE  
WBW10016132  
MSRP  
\$69.95

- Half-Moon Web
- Black/Blonde
- Smaller Hand Opening for a Snugger Fit

W

FASTPITCH GLOVES

# FASTPITCH GLOVES

2022

SECTION BRANDS

WILSON

AUBREE MUNRO  
USA Softball, C  
A2000 AM1 GM

# FASTPITCH GAME MODEL GLOVES

## FOR THE PROS, BY THE PROS

Wilson Game Model gloves aren't just worn by professionals. They're designed by them. Wilson Ball Glove Master Craftsman Shigeaki Aso sits down with select Advisory Staff members — either in person or on a video call — to craft a Game Model glove designed specifically for their play.

Aso-san's relentless passion drives his pursuit of the perfect glove. He collaborates with players to receive detailed feedback and ensure each glove is built to work for the player's game. Every glove has unique features, from the laces to the webbing and even the materials used, culminating in an innovative line of Wilson Game Model gloves.



### KELSEY STEWART

Sky Blue and White SnakeSkin™ brings a sharp new look to Kelsey Stewart's 2022 A2000® K7 game model glove. A modified X2 Web and Spin Control Technology® in the Sky Blue Pro Stock® Leather palm helps Kelsey control any ball hit her way, and red accents bring some flash to her game.

INFIELD 12"

ARTICLE  
WBW10043512  
MSRP  
\$279.95

#### KELSEY'S GLOVE FEATURES

- X2-Web
- Sky Blue/White SnakeSkin Pro Stock® Leather
- Spin Control® Dimpled Palm
- Game Model of Kelsey Stewart-A2000 K7 GM



### SIERRA ROMERO

Clean and Classic. Sierra Romero brings Spin Control Technology™ to Saddle Tan Pro Stock® Leather in the palm and web of her 2022 A2000® SR32 game model glove. Romero matches Saddle tan and Walnut Pro Stock® Leather with Blonde accents to create a look that will never go out of style.

INFIELD 12"

ARTICLE  
WBW10043412  
MSRP  
\$279.95

#### SIERRA'S GLOVE FEATURES

- Dual Post Web
- Saddle Tan/Walnut Pro Stock® Leather
- Spin Control® Dimpled Palm
- Game Model of Sierra Romero-A2000 SR32 GM



### AUBREE MUNRO

Not shy when it comes to bringing new tech to her game, catcher Aubree Munro worked Blonde Superskin and Spin Control Technology™ to her 2022 A2000® AM1 game model mitt. The dimpled pattern in the Pro Stock® Leather helps her take control behind the dish, and Sky Blue lace offers some pop and ties it all together.

CATCHER 34"

ARTICLE  
WBW10043634  
MSRP  
\$279.95

#### AUBREE'S GLOVE FEATURES

- V Web w/ Hinge
- Blonde Superskin™/Blonde Pro Stock® Leather
- Spin Control® Dimpled Palm
- Game Model of Aubree Munro-A2000 AM1 GM



# A2000® FP

## THE PREMIER GLOVE

A2000® gloves continue to evolve with the game. Durable Pro Stock® Leather offers a consistent feel and perfect break in. Comfort Pro™ Lining forms to your hand over time, pairing with our Comfort Sleeve wrist binding for the best feeling A2000® ever. Flat Finger Binding allows you to comfortably play with a finger out for improved control, and the Bold Logo package stands out on the diamond. The 2022 A2000® lineup also includes patterns built with Wilson's most innovative technologies, including the lightweight and durable SuperSkin™ and Spin Control Technology® — designed to increase friction between the ball and your glove.

1.

### PRO STOCK LEATHER®:

Made specifically for Wilson® ball gloves, this American steerhide is preferred by professional players for its rugged durability and unmatched feel.

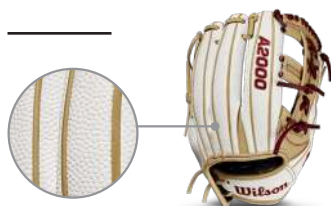

2.

### SUPERSKIN™:

Twice as strong as traditional Pro Stock® leather, but only half the weight, giving players the durability they love in a Wilson glove in a lightweight design.

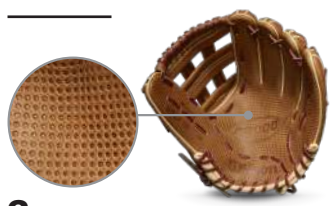

3.

### SPIN CONTROL TECHNOLOGY®:

A patented dimpled texture in our iconic Pro Stock® leather designed to increase the amount of friction between the ball and your glove, giving you more control.



4.

### DRAWSTRING CLOSURE:

Make in-game glove adjustments on the fly and ensure a secure fit in the field. Pull the long rawhide lace to set your wrist closure into place for the perfect fit.



NEW



INFIELD 11.75"  
ARTICLE  
WBW1004371175  
MSRP  
\$279.95

- A2000 H75
- H-Web
- Grey/White Pro Stock® Leather

SS



INFIELD 11.75"  
ARTICLE  
WBW1002081175  
MSRP  
\$279.95

- A2000 FP75
- Cross Web w/ 3X Lace
- White Superskin™/Blonde Pro Stock® Leather

NEW

GM



INFIELD 12"  
ARTICLE  
WBW10043512  
MSRP  
\$279.95

- A2000 KS27 GM
- X2 Web
- Sky Blue/White SnakeSkin Pro Stock® Select Leather
- Spin Control® Dimpled Palm
- Game Model of Kelsey Stewart

NEW

GM

SC



INFIELD 12"  
ARTICLE  
WBW10043412  
MSRP  
\$279.95

- A2000 SR32 GM
- Dual Post Web
- Saddle Tan/Walnut Pro Stock® Leather
- Spin Control® Dimpled Palm
- Game Model of Sierra Romero

NEW



INFIELD 12"  
ARTICLE  
WBW10043812  
MSRP  
\$279.95

- A2000 H12
- H-Web
- Blonde/Saddle Tan Pro Stock® Leather

NEW



PITCHER 12"  
ARTICLE  
WBW10043912  
WBW100440125 (LHT)  
MSRP  
\$279.95

- A2000 P12
- Closed Two-Piece Weave Web
- Blonde/Black Pro Stock® Leather

NEW

SS

SC



PITCHER/OUTFIELD 12.5"  
ARTICLE  
WBW100441125  
WBW100442125 (LHT)  
MSRP  
\$279.95

- A2000 VSS
- Victory Web
- Spin Control® Dimpled Palm
- Grey Superskin™/Grey Pro Stock® Leather

NEW

SS



1ST BASE 12"  
ARTICLE  
WBW100219125  
WBW100220125 (LHT)  
MSRP  
\$279.95

- A2000 FP1BSS
- Reinforced Single Post Web
- White Superskin™/Grey Pro Stock® Leather

NEW

GM

SS

SC



CATCHER 34"  
ARTICLE  
WBW10043634  
MSRP  
\$279.95

- AM1 GM
- V Web w/ Hinge
- Blonde Superskin™/Blonde Pro Stock® Leather
- Spin Control® Dimpled Palm
- Game Model of Aubree Munro



# A1000 FP

GAME READY

Grounders, line drives and fly balls don't stand a chance against A1000™ ball gloves, models crafted with soft yet sturdy leather that is game-ready on day one. There's no long winter break-in or sore knuckles from punching the leather. The A1000™ is ready to make an immediate impact whenever you are.



### DOUBLE PALM CONSTRUCTION (FRONT SIDE):

A thin, perfectly shaped piece of leather placed between the palm liner and outer shell, giving you what matters most: maximum pocket stability.

### FULL LEATHER CONSTRUCTION:

Leather shell, laces and pal liner. These ball gloves expertly break in and conform to your hand.

### LOW PROFILE HEEL (FRONT SIDE):

Gives more flexibility, opens up the palm and pocket and makes it more forgiving on bad hops.

### DRAWSTRING CLOSURE:

Make in-game glove adjustments on the fly and ensure a secure fit in the field. Pull the long rawhide lace to set your wrist closure into place for the perfect fit.



## A700®



**INFIELD** 12"  
ARTICLE  
WBW10042412  
WBW10042812 (LHT)  
MSRP  
\$84.95

- Dual Post Web
- Drawstring Wrist Closure
- Black/White Full Grain Leather



**OUTFIELD** 12.5"  
ARTICLE  
WBW100425125  
WBW100426125 (LHT)  
MSRP  
\$84.95

- Closed Victory Web
- Drawstring Wrist Closure
- Black/White Full Grain Leather



**CATCHER** 33"  
ARTICLE  
WBW10042733  
MSRP  
\$89.95

- Dual Post Web
- Drawstring Wrist Closure
- Black/White Full Grain Leather

## SIREN

A new Quick-Fit elastic band has been anchored to the back of the wrist, creating a secure fit for kids with smaller hands.



**INFIELD** 11.5"  
ARTICLE  
WBW100419115  
MSRP  
\$64.95

- H-Web
- New Quick-Fit Wrist™
- Black/Blonde/White



**INFIELD** 12"  
ARTICLE  
WBW10042012  
WBW10042112 (LHT)  
MSRP  
\$64.95

- Modified X2 Web
- New Quick-Fit Wrist™
- Black/White/Blonde



**OUTFIELD** 12.5"  
ARTICLE  
WBW100422125  
WBW100423125 (LHT)  
MSRP  
\$64.95

- V125
- New Quick-Fit Wrist™
- Black/Blonde/White



**INFIELD** 11.75"  
ARTICLE  
WBW1001781175  
MSRP  
\$139.95

- H-Web
- Drawstring Wrist Closure
- White/Blonde/Brick Red Full Grain Optima Leather



**INFIELD** 12"  
ARTICLE  
WBW10017912  
MSRP  
\$139.95

- Dual Post Web
- Drawstring Wrist Closure
- White/Black/Metallic Gold Full Grain Optima Leather



**PITCHER** 12"  
ARTICLE  
WBW10018012  
WBW10018112 (LHT)  
MSRP  
\$139.95

- Closed Two-Piece Web
- Drawstring Wrist Closure
- Black/Metallic Gold/White Full Grain Optima Leather



**OUTFIELD/PITCHER** 12.5"  
ARTICLE  
WBW100182125  
WBW100183125 (LHT)  
MSRP  
\$139.95

- Closed V-Shape Weave
- Drawstring Wrist Closure
- White/Black/Blonde Full Grain Optima Leather



**OUTFIELD** 12.5"  
ARTICLE  
WBW100184125  
WBW100185125 (LHT)  
MSRP  
\$139.95

- Pro Laced T-Web
- Drawstring Wrist Closure
- White/Black/Metallic Gold Full Grain Optima Leather



**1ST BASE** 12.5"  
ARTICLE  
WBW100430125  
WBW100431125 (LHT)  
MSRP  
\$139.95

- Single Post 3 Bar
- Drawstring Wrist Closure
- White/Blonde/Grey Full Grain Optima Leather



**CATCHER** 33"  
ARTICLE  
WBW10018633  
MSRP  
\$139.95

- Dual Post Web
- Drawstring Wrist Closure
- Grey/Blonde/White Full Grain Optima Leather

FLASH

**NEW**



**INFIELD** 11"  
 ARTICLE  
 WBW10040611  
 MSRP  
 \$49.95

- Closed Victory Web w/ Weave
- Black/Watermelon/Tropical Blue

**NEW**



**INFIELD** 11.5"  
 ARTICLE  
 WBW100415115  
 WBW100416115 (LHT)  
 MSRP  
 \$49.95

- Closed Corset Web
- Black/Watermelon/Tropical Blue

**NEW**



**OUTFIELD** 12"  
 ARTICLE  
 WBW10041712  
 WBW10041812 (LHT)  
 MSRP  
 \$49.95

- Split Web w/ Pro Lace
- Black/Watermelon/Tropical Blue

SLOWPITCH A360®



**ALL POSITIONS** 13"  
 ARTICLE  
 WBW10019213  
 WBW10019313 (LHT)  
 MSRP  
 \$49.95

- Closed w/ V-Laced Web
- Grey/Black
- Carbonlite Shell



**ALL POSITIONS** 14"  
 ARTICLE  
 WBW10042012  
 WBW10042112 (LHT)  
 MSRP  
 \$49.95

- Weave Web
- Grey/Black
- Carbonlite Shell



**ALL POSITIONS** 15"  
 ARTICLE  
 WBW100422125  
 WBW100423125 (LHT)  
 MSRP  
 \$49.95

- Dual Post Web w/ Double Bar
- Grey/Black
- Carbonlite Shell

GLOVE CARE



A2000® GLOVE CARE KIT

STOCK NO. WTA6763 TAN MSRP: \$49.99

Same kit used to repair A2000® gloves for big league players • Kit contains: Both black and tan rawhide lace, lacing tool, awl, cutters, threading needles, glove oil, brush and A2000 leather carry bag



PRO STOCK® GLOVE CONDITIONER 12 PC PDQ DISPLAY

STOCK NO. WTA6776PD MSRP: \$9.99 (EA.) \$119.99 (PDQ)

Makes the break-in process easier with premium conditioner that conditions, cleans and restores • Order in multiples of 12



PRO STOCK® GLOVE CONDITIONER 12 PC PDQ DISPLAY

STOCK NO. WTA6778PD MSRP: \$9.99 (ea.) \$119.99 (PDQ)

Extend the life of your Pro Stock® glove by using premium mink oil to restore and soften leather • Makes leather resistant to water and moisture • Order in multiples of 12

Teaming up once again, Wilson®, Louisville Slugger® and EvoShield® have created several products in partnership with Autism Speaks®. The organizations collaborated to create Love the Moment® bats and gloves that exist to spread the message of inclusion, acceptance and understanding for people on the autism spectrum. This collection perfectly showcases Autism Speaks' signature blue color and Love the Moment branding developed specifically for this partnership.



**NEW**  
2022 A2000 1786 11.5"  
ARTICLE  
WBW100391115  
MSRP  
\$279.95

- A2000 LTM86
- H-Web
- Autism Speaks® Blue Pro Stock® Leather



ALL POSITIONS 10"  
ARTICLE  
WTA02RB19AS  
MSRP  
\$21.95

- H-Web
- Grey/Sky Blue
- Smaller Hand Opening for a Snugger Fit
- Love The Moment



**NEW PRO-SRZ™ BATTER'S DOUBLE STRAP ELBOW GUARD**

ARTICLE	SIZE	COLOR	MAP
WB5722901	Large	X-SRZ Autism Speaks	\$74.95
WB5724801	Small	X-SRZ Autism Speaks	

ERGONOMIC DESIGN Engineered for a more personalized fit and maximum protection  
 GEL-TO-SHELL® TECHNOLOGY Begins soft and flexible, transforms to hard and protective in minutes  
 DISPERSION TECHNOLOGY Spreads the force across the surface of the shield, minimizing felt impact  
 SHIELD IS HAND WASHABLE Air dry  
 GUARD COVERAGE LARGE: [9.25" W x 9" H with double strap] SMALL: [9.25" W x 7" H with double strap]



**NEW PRO-SRZ™ BATTER'S ELBOW GUARD**

ARTICLE	SIZE	COLOR	MAP
WB5723001	Large	X-SRZ Autism Speaks	\$64.95
WB5724701	Small	X-SRZ Autism Speaks	

ERGONOMIC DESIGN Engineered for a more personalized fit and maximum protection  
 GEL-TO-SHELL® TECHNOLOGY Begins soft and flexible, transforms to hard and protective in minutes  
 DISPERSION TECHNOLOGY Spreads the force across the surface of the shield, minimizing felt impact  
 SHIELD IS HAND WASHABLE Air dry  
 GUARD COVERAGE LARGE: [9.25" W x 8.5" H with single strap] SMALL: [7.5" W x 5.5" H with single strap]



# BASEBALL BATS

2022



SECTION BRANDS

DEMARINI  
LOUISVILLE SLUGGER

LOVE THE MOMENT

BASEBALL BATS



DEMARINI® TOP COLLEGIATE PROGRAMS



BBCOR

BBCOR CERTIFIED .50



NEW



ZOA	2 5/8"	[31"/28] [32"/29] [33"/30] [34"/31]	WTDXZOA-22	-3	MSRP: \$499.95
-----	--------	-------------------------------------	------------	----	----------------

- CONTINUOUS FIBER COMPOSITE BARREL:** One durable sheet of ultra-strong composite material rolled into itself and crafted into a lighter, more durable barrel with a massive sweet spot and enhanced pop.
- CONSTRUCTION:** 2-Piece Composite designed to balance speed with power, the Anomaly Connection enables the seamless transfer of energy for better exit velocities.
- ANOMALY END CAP:** Built from an all-new blend of durable and lightweight materials, this end cap maintains barrel integrity and improves performance.
- PLAYER TYPE:** Built for the well-rounded player seeking the best combination of bat speed, barrel control and power.

NEW



CF	2 5/8"	[30"/27] [31"/28] [32"/29] [33"/30] [34"/31]	WTDXCBC-22	-3	MSRP: \$449.95
----	--------	--	------------	----	----------------

- PARAFLEX® PLUS COMPOSITE BARREL:** Developed to deliver a massive sweet spot and maximum barrel control.
- CONSTRUCTION:** 2-Piece Composite featuring the 3 Fusion™ Connection and Paraflex™ Plus Composite handle deliver maximum energy transfer to the barrel, not your hands
- ReACTION END CAP:** Built with a blend of stronger and lighter materials to increase barrel performance without sacrificing swing speed.
- PLAYER TYPE:** Built for gap-to-gap contact hitters seeking greater bat speed and a forgiving feel on contact.

NEW



THE GOODS	2 5/8"	[31"/28] [32"/29] [33"/30] [34"/31]	WTDXGIC-22	-3	MSRP: \$399.95
-----------	--------	-------------------------------------	------------	----	----------------

- X14 ALLOY BARREL:** A massive alloy barrel designed specifically with elite power hitters in mind.
- HALF + HALF:** 2-Piece Hybrid with our NEW Direct Connection and Paraflex™ Plus Composite handle tuned for power hitters.
- TREMOR END CAP:** Redesigned with stronger materials, this new end cap helps maintain the durability and power of our massive X14 Alloy Barrel.
- PLAYER TYPE:** Built for power, our heaviest swinging BBCOR bat allows players to generate insane force.

BBCOR

BBCOR CERTIFIED .50



NEW



VOODOO® ONE	2 5/8"	[29"/26] [30"/27] [31"/28] [32"/29] [33"/30] [34"/31]	WTDXVOC-22	-3	MSRP: \$349.95
-------------	--------	---	------------	----	----------------

- X14 ALLOY BARREL:** Lightweight performance alloy built for maximum pop and durability, without sacrificing swing speed.
- CONSTRUCTION:** 1-Piece Alloy designed to reduce vibration in your hands while taking advantage of the increased stiffness.
- TRACER END CAP:** Molded with lightweight composite materials, this new end cap is designed to enhance bat speed while maintaining powerful barrel performance.
- PLAYER TYPE:** Built for the player who wants a light-swinging bat to generate massive swing speeds.

NEW



THE GOODS ONE PIECE	2 5/8"	[31"/28] [32"/29] [33"/30] [34"/31]	WTDXGOC-22	-3	MSRP: \$349.95
---------------------	--------	-------------------------------------	------------	----	----------------

- X14 ALLOY BARREL:** A massive alloy barrel designed specifically with elite power hitters in mind.
- CONSTRUCTION:** 1-Piece Alloy that maximizes stiffness for a feel that mirrors wood bats.
- TREMOR END CAP:** Redesigned with stronger materials, this new end cap helps maintain the durability and power of our massive X14 Alloy Barrel.
- PLAYER TYPE:** Slightly more mass in the barrel for players looking for more power.



WOOD COMPOSITE

BBCOR CERTIFIED .50



D271 PRO MAPLE™	« BALANCED »	[31"] [32"] [33"] [34"]	MODEL NO. WTDX271BW18	-3	MSRP: \$199.95
-----------------	--------------	-------------------------	-----------------------	----	----------------

- M** MAPLE
- A** APPROVED FOR SHORT SEASON A
- R** APPROVED FOR ROOKIE BALL
- PG** APPROVED FOR PERFECT GAME PLAY



D243 PRO MAPLE™	« ENDOLOADED »	[31"] [32"] [33"] [34"]	MODEL NO. WTDX243BN18	-3	MSRP: \$199.95
-----------------	----------------	-------------------------	-----------------------	----	----------------

- M** MAPLE
- A** APPROVED FOR SHORT SEASON A
- R** APPROVED FOR ROOKIE BALL
- PG** APPROVED FOR PERFECT GAME PLAY



D110 PRO MAPLE™	« BALANCED »	[31"] [32"] [33"] [34"]	MODEL NO. WTDX110B018	-3	MSRP: \$199.95
-----------------	--------------	-------------------------	-----------------------	----	----------------

- M** MAPLE
- PG** APPROVED FOR PERFECT GAME PLAY



D113 PRO MAPLE™	« ENDOLOADED »	[31"] [32"] [33"] [34"]	MODEL NO. WTDX113BG18	-3	MSRP: \$199.95
-----------------	----------------	-------------------------	-----------------------	----	----------------

- M** MAPLE
- PG** APPROVED FOR PERFECT GAME PLAY

FUNGO



FUNGO DELIC™ PRO MAPLE™ WOOD COMPOSITE		[35"/23]	MODEL NO. WTDXFUNDE1835		MSRP: \$99.99
--	--	----------	-------------------------	--	---------------

- M** MAPLE
- WB** WOOD BARREL: For traditional Fungo feel.
- END** END LOADED FEEL: With weight in the barrel for best ground ball and fly ball hitting.



WOOD FUNGO		[35"]	MODEL NO. WTDXFUNW35		MSRP: \$99.99
------------	--	-------	----------------------	--	---------------

- M** MAPLE
- H** HITTING: Designed for hitting infield and outfield Fungos.



LOUISVILLE SLUGGER® TOP COLLEGIATE PROGRAMS



BBCOR

BBCOR CERTIFIED .50



META®	2 5/8"	[31"/28] [32"/29] [33"/30] [34"/31]	WBL2522010	-3	MSRP: \$499.95
-------	--------	-------------------------------------	------------	----	----------------

- BARREL:** EKO™ Composite—engineered to the pinnacle of performance; light swinging, huge barrel, and the truest sound in the game.
- CONSTRUCTION:** 3-piece design with patented 3FX™ Connection System provides a perfectly tuned “stiff” feel on contact while dramatically reducing vibration.
- END CAP:** Premium GT1™ end cap that maximizes barrel length and swing speed.
- SWING WEIGHT:** Balanced swing for the ultimate combination of speed and power.
- PREMIUM LS® PRO COMFORT GRIP™:** For the perfect mix of tack and cushion.



SELECT PWR	2 5/8"	[31"/28] [32"/29] [33"/30] [34"/31]	WBL2524010	-3	MSRP: \$399.95
------------	--------	-------------------------------------	------------	----	----------------

- BARREL:** EXD™ premium alloy barrel for increased barrel and sweet spot size.
- CONSTRUCTION:** 3-piece design – composite handle with 3FX-PWR™ Connection System that provides extra stiffness for power hitters looking for more energy transfer and less vibration.
- END CAP:** PWR™ End Cap design for increased momentum and power on your swing.
- SWING WEIGHT:** Power swing weight for increased momentum and maximum distance.
- PREMIUM LS® PRO COMFORT GRIP™:** For the perfect mix of tack and cushion.



SOLO	2 5/8"	[29"/26] [30"/27] [31"/28] [32"/29] [33"/30] [34"/31]	WTLBBS622B3	-3	MSRP: \$299.95
------	--------	---	-------------	----	----------------

- BARREL:** Premium SL Hyper™ (29"-30") and Premium SL Hyper+™ (31"-34") superlight alloy with thinner wall design for maximum pop.
- CONSTRUCTION:** 1-piece design with VIBEX™ premium vibration damping handle construction that reduces sting on mishits.
- END CAP:** SPD™ Composite End Cap removes weight for increased swing speed.
- SWING WEIGHT:** Ultra-balanced swing weight—our lightest swinging BBCOR model.
- PREMIUM LS® PRO COMFORT GRIP™:** For the perfect mix of tack and cushion.



VAPOR	2 5/8"	[30"/27] [31"/28] [32"/29] [33"/30] [34"/31]	WTLBBVAB320	-3	MSRP: \$99.99
-------	--------	--	-------------	----	---------------

- BARREL:** Series 7 alloy for maximum durability and performance at an unbelievable value.
- CONSTRUCTION:** 1-piece design for maximum stiffness on contact.
- END CAP:** Durable HUB™ 1-shot end cap design.
- GRIP:** Standard synthetic leather grip for better bat control.



## USSSA/SENIOR LEAGUE



NEW



ZOA	2 3/4"	[28"/18] [29"/19] [30"/20] [31"/21]	WTDXZBZ-22	-10	MSRP: \$399.95
	2 3/4"	[29"/21] [30"/22] [31"/23] [32"/24]	WTDXZBZ-22	-8	
	2 5/8"	[30"/25] [31"/26] [32"/27] [33"/28]	WTDXZB5-22	-5	

- CONTINUOUS FIBER COMPOSITE BARREL:** One durable sheet of ultra-strong composite material rolled into itself and crafted into a lighter, more durable barrel with a massive sweet spot and enhanced pop.
- CONSTRUCTION:** 2-Piece Composite designed to balance speed with power, the Anomaly Connection enables the seamless transfer of energy for better exit velocities.
- ANOMALY END CAP:** Built from an all-new blend of durable and lightweight materials, this end cap maintains barrel integrity and improves performance.
- PLAYER TYPE:** Built for the elite ball player looking for the most advanced technological features available for USSSA.

NEW

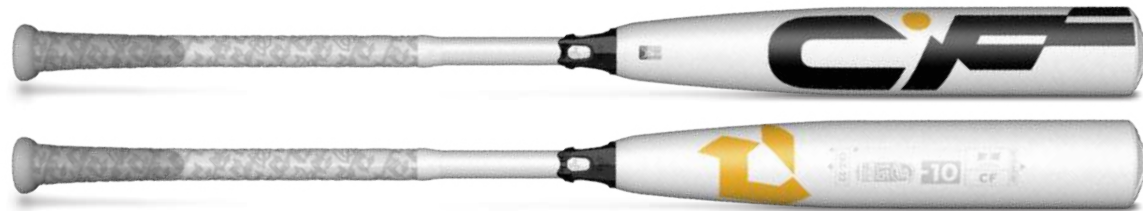

CF	2 3/4"	[28"/18] [29"/19] [30"/20] [31"/21]	WTDXC8Z-22	-10	MSRP: \$349.95
	2 3/4"	[29"/21] [30"/22] [31"/23] [32"/24]	WTDXC8Z-22	-8	
	2 5/8"	[30"/25] [31"/26] [32"/27] [33"/28]	WTDXC85-22	-5	

- PARAFLEX® PLUS COMPOSITE BARREL:** Our legacy composite that has dominated USSSA for years by delivering a massive sweet spot and premium barrel control.
- CONSTRUCTION:** 2-Piece Composite featuring the 3 Fusion™ Connection and Paraflex™ Plus Composite handle deliver maximum energy transfer to the barrel, not your hands.
- ReACTION END CAP:** Built with a blend of stronger and lighter materials to increase barrel performance without sacrificing swing speed.
- PLAYER TYPE:** Built for the well-rounded player seeking the best combination of bat speed, barrel control and power.

NEW



THE GOODS ONE PIECE	2 3/4"	[26"/16] [27"/17] [28"/18] [29"/19] [30"/20] [31"/21]	WTDXG0Z-22	-10	MSRP: \$249.95
	2 3/4"	[29"/21] [30"/22] [31"/23] [32"/24]	WTDXG08-22	-8	

- X14 ALLOY BARREL:** Precision engineered with the most consistent walls possible that lead the pack in alloy performance, while maintaining durability and swing speed.
- CONSTRUCTION:** 1-Piece Alloy designed to reduce vibration in your hands while taking advantage of the increased stiffness.
- TRACER END CAP:** Molded with lightweight composite materials, this new end cap is designed to enhance bat speed while maintaining powerful barrel performance.
- PLAYER TYPE:** Built for the player who wants a light-swinging bat to generate massive swing speeds.



## USSSA/SENIOR LEAGUE



NEW

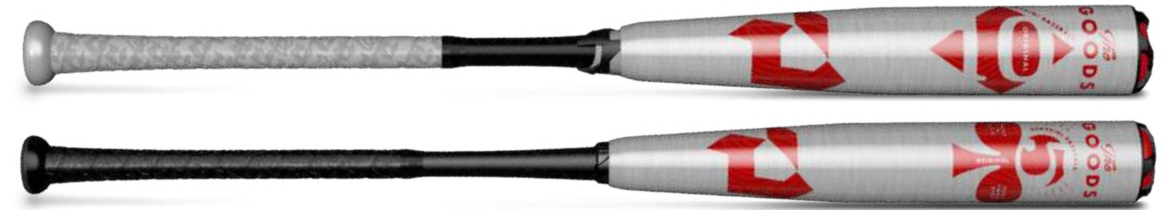

THE GOODS	2 3/4"	[28"/18] [29"/19] [30"/20] [31"/21]	WTDXGBZ-22	-10	MSRP: \$299.95
	2 5/8"	[30"/25] [31"/26] [32"/27] [33"/28]	WTDXGB5-22	-5	

- X14 ALLOY BARREL:** Precision engineered with the most consistent walls possible that lead the pack in alloy performance, while maintaining durability and swing speed.
- HALF + HALF:** -10: 2-Piece Hybrid featuring the New Type-V Connection and Paraflex™ Plus Composite handle deliver improved bat speed and premium feel on contact.
- TRACER END CAP:** -10: Molded with lightweight composite materials, this new end cap is designed to enhance bat speed while maintaining powerful barrel performance.
- PLAYER TYPE:** -10: Built for players that wants premium bat speed and barrel control with a hybrid bat feel.
- HALF + HALF:** -5: 2-Piece Hybrid featuring the New Direct Connection and Paraflex™ Plus Composite handle deliver greater power for players approaching BBCOR play.
- TREMOR END CAP:** -5: Redesigned with stronger materials, this new end cap helps maintain the durability and power of our massive X14 Alloy Barrel.
- PLAYER TYPE:** -5: Built for the player searching for increased power and the feel of a hybrid bat as they approach BBCOR play.

NEW



UPRISING JBB	2 3/4"	[26"/16] [27"/17] [28"/18] [29"/19] [30"/20]	WBD2234010	-10	MSRP: \$99.95
--------------	--------	--	------------	-----	---------------

- DX1™ ALLOY BARREL:** High strength alloy built for performance and durability.
- CONSTRUCTION:** 1-Piece Alloy designed for increased bat control.
- ION D END CAP:** Built to provide a lighter swing weight.
- PLAYER TYPE:** Engineered for younger players looking for a light-swinging performance bat.



### USSSA/SENIOR LEAGUE



NEW



META® SL	2 3/4"	[27"/17] [28"/18] [29"/19] [30"/20] [31"/21]	WBL2528010	-10	MSRP: \$349.95
	2 3/4"	[29"/21] [30"/22] [31"/23] [32"/24]	WBL2529010	-8	
	2 5/8"	[30"/25] [31"/26] [32"/27]	WBL2530010	-5	

**BARREL:** EKO™ Composite—engineered to the pinnacle of performance; light swinging, large barrel profile and optimized sweet spot.

**CONSTRUCTION:** 3-piece design featuring VCX2™ Vibration Control Connection System—a patented elastomeric connection that allows independent movement between the barrel and the handle to control vibration and provide unmatched feel on contact.

**END CAP:** Premium GT1™ end cap that maximizes barrel length and swing speed.

**SWING WEIGHT:** Balanced swing weight for the ultimate combination of speed and power.

**PREMIUM LS® PRO COMFORT GRIP™:** For the perfect mix of tack and cushion.

NEW



META® ONE	2 3/4"	[27"/17] [28"/18] [29"/19] [30"/20] [31"/21]	WBL2531010	-12	MSRP: \$249.95
-----------	--------	--	------------	-----	----------------

**BARREL:** EKO™ Composite—engineered to the pinnacle of performance; light swinging, large barrel profile and optimized sweet spot.

**CONSTRUCTION:** 1-piece construction for stiffer feel on contact and more energy transfer.

**END CAP:** Premium GT1™ end cap that maximizes barrel length and swing speed.

**SWING WEIGHT:** Balanced swing weight for the ultimate combination of speed and power.

**PREMIUM LS® PRO COMFORT GRIP™:** For the perfect mix of tack and cushion.

NEW



SOLO	2 3/4"	[26"/16] [27"/17] [28"/18] [29"/19] [30"/20] [31"/21]	WTL6X1022	-10	MSRP: \$249.95
	2 3/4"	[29"/21] [30"/22] [31"/23] [32"/24]	WTL6X0822	-8	
	2 5/8"	[30"/25] [31"/26] [32"/27]	WTL6B0522	-5	

**BARREL:** Premium SL Hyper™ superlight alloy with thinner wall design for maximum pop.

**CONSTRUCTION:** 1-piece construction designed for maximum speed through the zone.

**END CAP:** SPD™ Composite End Cap removes weight for increased swing speed.

**SWING WEIGHT:** Ultra-balanced swing weight for increased swing speed.

**PREMIUM LS® PRO COMFORT GRIP™:** For the perfect mix of tack and cushion.

NEW



SOLO JBB	2 3/4"	[25"/15] [26"/16] [27"/17] [28"/18]	WBL2535010	-10	MSRP: \$99.99
----------	--------	-------------------------------------	------------	-----	---------------

**BARREL:** Premium SL Hyper™ superlight alloy with thinner wall design for maximum pop.

**CONSTRUCTION:** 1-piece construction for stiffer feel on contact and more energy transfer.

**END CAP:** 6-Star™ premium end cap design for power and performance.

**SWING WEIGHT:** Balanced swing weight that is easy to swing through the zone.

**STANDARD BASEBALL GRIP:** With improved cushion.



### USA BASEBALL



NEW



CF	2 5/8"	[29"/19] [30"/20] [31"/21] [32"/22]	WTDXUF22	-10	MSRP: \$349.95
----	--------	-------------------------------------	----------	-----	----------------

**PARAFLEX® PLUS COMPOSITE BARREL:** Developed to deliver a massive sweet spot and maximum barrel control, this is the most consistently high-performing barrel in the game.

**CONSTRUCTION:** 2-Piece Composite featuring the 3 Fusion™ Connection and Paraflex™ Plus Composite handle deliver maximum energy transfer to the barrel, not your hands.

**ReACTION END CAP:** Built with a blend of stronger and lighter materials to increase barrel performance without sacrificing swing speed.

**PLAYER TYPE:** Built for the well-rounded player seeking the best combination of bat speed, barrel control and power.

NEW



THE GOODS	2 5/8"	[28"/18] [29"/19] [30"/20] [31"/21] [32"/22]	WTDXUG2-22	-10	MSRP: \$249.95
-----------	--------	--	------------	-----	----------------

**X14 ALLOY BARREL:** Precision engineered with the most consistent walls possible that lead the pack in alloy performance, while maintaining durability and swing speed.

**HALF + HALF:** 2-Piece Composite featuring the new Type-V Connection and Paraflex™ Plus Composite handle deliver maximum energy transfer to the barrel, not your hands.

**TRACER END CAP:** Molded with lightweight composite materials, this new end cap is designed to enhance bat speed while maintaining powerful barrel performance.

**PLAYER TYPE:** Built for players that want premium bat speed, barrel control and power with a hybrid bat feel.

NEW



THE GOODS ONE PIECE	2 5/8"	[28"/18] [29"/19] [30"/20] [31"/21] [32"/22]	WTDXU02-22	-10	MSRP: \$179.95
	2 5/8"	[30"/25] [31"/26] [32"/27] [33"/28]	WTDXU05-22	-5	

**X14 ALLOY BARREL:** Precision engineered with the most consistent walls possible that lead the pack in alloy performance, while maintaining durability and swing speed.

**CONSTRUCTION:** 1-Piece Alloy designed to reduce vibration in your hands while taking advantage of the increased stiffness.

**TRACER END CAP:** Molded with lightweight composite materials, this new end cap is designed to enhance bat speed while maintaining powerful barrel performance.

**PLAYER TYPE:** Built for the player who wants to generate massive swing speeds with a lightweight performance bat.

NEW



UPRISING	2 1/2"	[26"/15] [27"/16] [28"/17] [29"/18] [30"/19] [31"/20] [32"/21]	WBD2235010	-11	MSRP: \$99.99
----------	--------	--	------------	-----	---------------

**DX1™ ALLOY BARREL:** High strength alloy built for performance and durability.

**CONSTRUCTION:** 1-Piece Alloy designed for increased bat control.

**ION D END CAP:** Built to provide a lighter swing weight.

**PLAYER TYPE:** Engineered for younger players looking to prioritize swing speed.



USA BASEBALL



<b>PRIME®</b>	<b>2 5/8"</b>	[28"/18] [29"/19] [30"/20] [31"/21]	WBL2536010	-10	MSRP: \$349.95
---------------	---------------	-------------------------------------	------------	-----	----------------

**BARREL:** Premium AVC MicroForm™ composite with optimized sweet spot and swing weight.

**CONSTRUCTION:** 3-Piece design featuring VCX™ Vibration Control Connection System—a patented elastomeric connection that allows independent movement between the barrel and the handle to control vibration and provide unmatched feel on contact.

**END CAP:** Premium RTX™ end cap design maximizes the barrel shape and sweet spot.

**SWING WEIGHT:** Balanced swing weight for the ultimate combination of speed and power.

**PREMIUM LS® PRO COMFORT GRIP™:** For the perfect mix of tack and cushion.



<b>SOLO</b>	<b>2 5/8"</b>	[28"/17] [29"/18] [30"/19] [31"/20] [32"/21]	WBL2537010	-11	MSRP: \$179.95
-------------	---------------	--	------------	-----	----------------

**BARREL:** Premium SL Hyper™ superlight alloy with thinner wall design for maximum pop.

**CONSTRUCTION:** 1-Piece construction designed for maximum speed through the zone.

**END CAP:** (SBC) Speed Ballistic Composite End Cap for increased swing speed and control.

**SWING WEIGHT:** Ultra-balanced swing weight for increased swing speed on a USA bat.

**PREMIUM LS® PRO COMFORT GRIP™:** For the perfect mix of tack and cushion.



<b>OMAHA®</b>	<b>2 5/8"</b>	[26"/16] [27"/17] [28"/18] [29"/19] [30"/20] [31"/21]	WBL2538010	-10	MSRP: \$99.95
---------------	---------------	---	------------	-----	---------------

**BARREL:** ST7 alloy for more power on contact.

**CONSTRUCTION:** 1-Piece construction for stiffer feel on contact and more energy transfer.

**END CAP:** Durable HUB™ 1-shot end cap design.

**SWING WEIGHT:** Balanced swing weight that feels great through the zone.

**STANDARD SYNTHETIC LEATHER GRIP:** For better bat control.



<b>VAPOR</b>	<b>2 5/8"</b>	[27"/18] [28"/19] [29"/20] [30"/21] [31"/22] [32"/23]	WBL2539010	-9	MSRP: \$59.99
--------------	---------------	---	------------	----	---------------

**BARREL:** Series 7 Premium alloy for performance at an unbelievable value.

**CONSTRUCTION:** 1-Piece design for maximum stiffness on contact.

**END CAP:** Durable HUB™ 1-shot end cap design.

**STANDARD SYNTHETIC LEATHER GRIP:** For better bat control.



TEEBALL

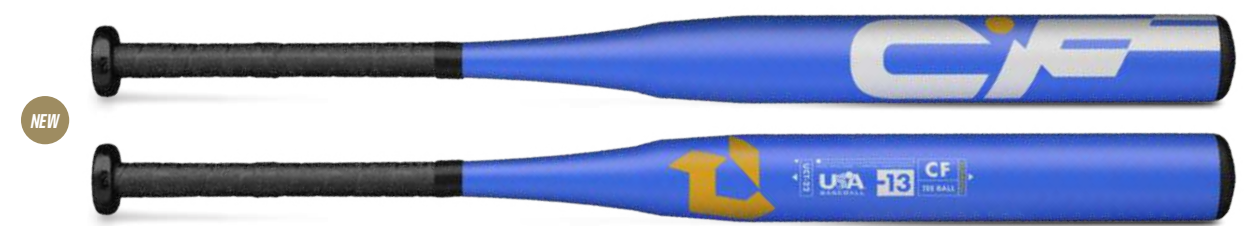

<b>CF TEEBALL</b>	<b>2 1/2"</b>	[25"/12] [26"/13]	WTDXUCT-22	-13	MSRP: \$34.99
-------------------	---------------	-------------------	------------	-----	---------------

**TP** TP COMPOSITE BARREL: Tailored for use with approved T-Balls.

**HH** HALF + HALF: 2-Piece Composite barrel and handle for light flex and more performance.

**ION D** ION D END CAP: Provides a lighter swing weight.

**PT** PLAYER TYPE: Built for Tee Ball players looking for a very lightweight bat.



TEEBALL



<b>META TEEBALL</b>	<b>2 5/8"</b>	[25"/12] [26"/13]	WBL2491010	-13	MSRP: \$74.95
---------------------	---------------	-------------------	------------	-----	---------------

**BARREL:** 100% composite – for use with approved Teeballs.

**CONSTRUCTION:** 1-Piece construction designed for maximum speed through the zone.

**END CAP:** Molded design to maximize barrel profile and increase swing speed.

**PREMIUM LS® PRO COMFORT GRIP™:** For the perfect mix of tack and cushion.



<b>PRIME TEEBALL</b>	<b>2 1/2"</b>	[24"/11.5] [25"/12.5] [26"/13.5]	WBL2540010	-12.5	MSRP: \$39.99
----------------------	---------------	----------------------------------	------------	-------	---------------

**BARREL:** 100% alloy – for use with approved Teeballs.

**CONSTRUCTION:** 1-Piece design for an easy to swing light design.

**END CAP:** Durable HUB™ 1-shot end cap design.

**PREMIUM LS® PRO COMFORT GRIP™:** For the perfect mix of tack and cushion.



2022

# FASTPITCH BATS

## SECTION BRANDS

DEMARINI  
LOUISVILLE SLUGGER

DEMARINI® TOP COLLEGIATE PROGRAMS



FASTPITCH



PRISM+	2 1/4"	[28"/17] [29"/18] [30"/19] [31"/20] [32"/21] [33"/22]	WTDXPZS-21	-11	MSRP: \$399.95
		[31"/21] [32"/22] [33"/23] [34"/24]	WTDXPZP-21	-10	

- GAPPED WALL BARREL WITH CONTINUOUS FIBER COMPOSITE:** Multiple composite walls with re-targeted weighting work in tandem to deliver the ultimate performance barrel in Fastpitch
- CONSTRUCTION:** 2-Piece Composite featuring the Type-V™ Connection and Paraflex™ Plus Composite handle deliver maximum energy transfer to the barrel, not your hands.
- REFRACT END CAP:** Helps players generate extreme bat speed and take advantage of the elite performance of the Prism.
- PLAYER TYPE:** Built for the well-rounded player looking for the highest performing bat on the market.



CF	2 1/4"	[28"/17] [29"/18] [30"/19] [31"/20] [32"/21] [33"/22]	WTDXCFS-22	-11	MSRP: \$399.95
		[30"/20] [31"/21] [32"/22] [33"/23] [34"/24]	WTDXCFP-22	-10	

- PARAFLEX™ PLUS COMPOSITE:** Developed to deliver a massive sweet spot and maximum barrel control, this is the most consistently high-performing barrel in the game.
- CONSTRUCTION:** 2-Piece Composite featuring the Type-V™ Connection and Paraflex™ Plus Composite handle deliver maximum energy transfer to the barrel, not your hands.
- TRACER END CAP:** Molded with lightweight composite materials, this new end cap is designed to enhance bat speed while maintaining powerful barrel performance.
- PLAYER TYPE:** Perfect for the elite player looking to generate extreme swing speed without giving up power.



CF	2 1/4"	[32"/23] [33"/24] [34"/25]	WTDXCFF-22	-9	MSRP: \$399.95
----	--------	----------------------------	------------	----	----------------

- PARAFLEX™ PLUS COMPOSITE:** Developed to deliver a massive sweet spot and maximum barrel control, this is the most consistently high-performing barrel in the game.
- CONSTRUCTION:** 2-Piece Composite featuring the Type-V™ Connection and Paraflex™ Plus Composite handle deliver maximum energy transfer to the barrel, not your hands.
- TREMOR END CAP:** Redesigned with stronger materials, this new end cap helps maintain the durability and power of our Paraflex Plus™ Composite Barrel.
- PLAYER TYPE:** Designed for stronger players looking to generate more power with a balanced feeling swing.



CF	2 1/4"	[33"/25] [34"/26]	WTDXCF8-22	-8	MSRP: \$399.95
----	--------	-------------------	------------	----	----------------

- PARAFLEX™ PLUS COMPOSITE:** Developed to deliver a massive sweet spot and maximum barrel control, this is the most consistently high-performing barrel in the game.
- CONSTRUCTION:** 2-Piece Composite featuring the Direct Connection and Paraflex™ Plus Composite handle designed for a stiffer feeling to deliver greater power.
- TREMOR END CAP:** Redesigned with stronger materials, this new end cap helps maintain the durability and power of our Paraflex Plus™ Composite Barrel.
- PLAYER TYPE:** Built for elite power hitters who need a heavier bat to match their game.



FASTPITCH



SPRYTE	2 1/4"	[29"/17] [30"/18] [31"/19] [32"/20] [33"/21]	WTDXSPF-22	-12	MSRP: \$229.95
--------	--------	--	------------	-----	----------------

- PARADOX™ COMPOSITE BARREL:** Designed to perform with a softer, hotter, and more responsive feel for younger players.
- CONSTRUCTION:** 100% Composite 2-Piece Design that utilizes our D-Lite™ Handle to reduce vibration for a smooth feel on every swing.
- BIG D™ END CAP:** Helps to absorb vibration so hitters can swing with confidence.
- PLAYER TYPE:** Built for the developing player who wants a bat that will help generate more bat speed.



ZENITH	2 1/4"	[29"/16] [30"/17] [31"/18] [32"/19]	WDXDPFP-22	-13	MSRP: \$124.99
--------	--------	-------------------------------------	------------	-----	----------------

- DX1™ ALLOY BARREL:** High strength alloy built for performance and durability.
- HALF + HALF:** Featuring the TP handle that helps hitters swing for the fences, without worrying about contact vibration.
- BIG D™ END CAP:** Helps to absorb vibration so hitters can swing with confidence.
- PLAYER TYPE:** Engineered for younger players looking for a light-swinging performance bat.



UPRISING	2 1/4"	[28"/16] [29"/17] [30"/18] [31"/19] [32"/20]	WBD2236010	-13	MSRP: \$79.99
----------	--------	--	------------	-----	---------------

- DX1™ ALLOY BARREL:** High strength alloy built for performance and durability.
- CONSTRUCTION:** 1-Piece design for a responsive feel.
- BIG D™ END CAP:** Helps to absorb vibration so hitters can swing with confidence.
- PLAYER TYPE:** Engineered for younger players looking for a light-swinging performance bat.



LOUISVILLE SLUGGER® TOP COLLEGIATE PROGRAMS



FASTPITCH



META®	2 1/4"	[30"/20] [31"/21] [32"/22] [33"/23] [34"/24]	WBL2492010	-10	MSRP: \$449.95
		[32"/23] [33"/24] [34"/25]	WBL2495010	-9	
		[33"/25] [34"/26]	WBL2496010	-8	

- BARREL:** NEW Mash Composite barrel engineered to be the highest performing fastpitch barrel in the game with an unmistakable sound.
- CONSTRUCTION:** NEW 2-Piece design featuring our VTX Connection designed to work with our MASH composite barrel to deliver better energy transfer and improved feel.
- END CAP:** NEW F2X End Cap - Designed to work specifically with the Meta's gapped wall platform.
- SWING WEIGHT:** Balanced swing weight for extreme control and maximum swing speed.
- PREMIUM LS® PRO COMFORT GRIP™:** With increased tack and cushion for better feel and more control.



RXT	2 1/4"	[30"/20] [31"/21] [32"/22] [33"/23] [34"/24]	WBL2448010	-10	MSRP: \$399.95
		[32"/23] [33"/24] [34"/25]	WBL2449010	-9	
		[33"/25] [34"/26]	WBL2450010	-8	

- BARREL:** Responsive Composite Design with patented HVR-1 Technology™ for an extremely responsive barrel that delivers maximum pop that you can feel.
- CONSTRUCTION:** 2-Piece design featuring a SPRINGLOAD™ Connection System – for a more responsive bat that improves feel on contact and drives the ball through the zone.
- END CAP:** COPA™ performance end cap works with the barrel to maximize the sweet spot.
- SWING WEIGHT:** Balanced swing weight for extreme control and maximum swing speed.
- LS® PRO COMFORT GRIP™:** With increased tack and cushion for better feel and more control.



LXT™	2 1/4"	[28"/17] [29"/18] [30"/19] [31"/20] [32"/21] [33"/22]	WBL2542010	-11	MSRP: \$399.95
		[30"/20] [31"/21] [32"/22] [33"/23] [34"/24]	WBL2543010	-10	
		[32"/23] [33"/24] [34"/25]	WBL2544010	-9	
		[33"/25] [34"/26]	WBL2545010	-8	

- BARREL:** Speed Composite Design with patented single disk–PBF Technology™ for maximum pop, a huge sweet spot, and unbelievable sound on contact.
- CONSTRUCTION:** 3-Piece design featuring UPDATED VCX2™ Vibration Control Connection System—a patented elastomeric connection that allows independent movement between the barrel and the handle to control vibration and provide unmatched feel on contact.
- END CAP:** COPA™ performance end cap works with the barrel to maximize the sweet spot.
- SWING WEIGHT:** Balanced swing weight for extreme control and maximum swing speed.
- PREMIUM LS® PRO COMFORT GRIP™:** For the perfect mix of tack and cushion.



FASTPITCH



NEW



<b>NEXUS</b>	2 1/4"	[28"/16] [29"/17] [30"/18] [31"/19] [32"/20] [33"/21]	WBL2459010	-12	MSRP: \$229.95
--------------	--------	---	------------	-----	----------------

**BARREL:** 100% Performance Composite Design that allows for a large sweet spot and control at the plate.

**CONSTRUCTION:** 2-Piece design featuring the XCT Connection to control vibration and deliver great feel on contact.

**END CAP:** Ultra lightweight X-Cap™ design for improved speed and control at the plate.

**SWING WEIGHT:** Balanced swing weight that is perfect for all player types.

**STANDARD FASTPITCH GRIP** With improved cushion.

NEW



<b>PROVEN</b>	2 1/4"	[28"/15] [29"/16] [30"/17] [31"/18] [32"/19] [33"/20]	WBL2550010	-13	MSRP: \$124.99
---------------	--------	---	------------	-----	----------------

**BARREL:** Full composite design with an engineered sweet spot for improved pop and feel.

**CONSTRUCTION:** 1-Piece design for a solid feel on contact.

**SWING WEIGHT:** Ultra balanced—light & easy to swing for increased control and bat speed.

NEW



<b>QUEST</b>	2 1/4"	[27"/15] [28"/16] [29"/17] [30"/18] [31"/19] [32"/20] [33"/21]	WBL2551010	-12	MSRP: \$64.99
--------------	--------	--	------------	-----	---------------

**BARREL:** Full performance alloy for increased durability and swing speed.

**CONSTRUCTION:** 1-Piece design for a solid feel on contact.

**SWING WEIGHT:** Ultra balanced—light & easy to swing for increased control and bat speed.

NEW



<b>DIVA</b>	2 1/4"	[27"/15.5] [28"/16.5] [29"/17.5] [30"/18.5] [31"/19.5]	WBL2552010	-11.5	MSRP: \$34.99
-------------	--------	--	------------	-------	---------------

**BARREL:** Full alloy construction engineered specifically for the youth player.

**CONSTRUCTION:** 1-Piece design that delivers performance at a great value.

**SWING WEIGHT:** Ultra balanced—light & easy to swing for younger players.

# SLOWPITCH BATS



2022

SECTION BRANDS

DEMARINI

SLOWPITCH BATS



ALL ASSOCIATION



STEEL	2 1/4"	[34"/26] [34"/27] [34"/28]	WTDXSTL-22	MSRP: \$249.95
-------	--------	----------------------------	------------	----------------

**12" CARBURIZED SEAMLESS DRAWN STEEL BARREL:**  
For increased performance, strength and durability. Designed Specifically for DeMarini®

**ZNX ALLOY HANDLE:**  
2-Piece design with less flex, increased barrel deflection and increased overall performance.



ULTIMATE WEAPON™	2 1/4"	[34"/25] [34"/26] [34"/27] [34"/28]	WTDXUWE-22	MSRP: \$159.99
------------------	--------	-------------------------------------	------------	----------------

**12" SC4™ ALLOY BARREL:**  
Built for a solid feel on contact.

**CONSTRUCTION:**  
1-Piece Alloy construction.



WINDY CITY™	2 1/4"	[34"/32] [34"/34] [34"/36] [34"/38]	WTDXWCS-22	MSRP: \$159.99
-------------	--------	-------------------------------------	------------	----------------

**12.5" SC4™ ALLOY BARREL:**  
Built specifically for mushball to create a solid feel on contact.

**CONSTRUCTION:**  
Single wall, 1-Piece construction.



CORNDOG™ WOOD COMPOSITE	2 1/4"	[34"/27] [34"/28]	WBD2237010	MSRP: \$199.95
-------------------------	--------	-------------------	------------	----------------

**PRO MAPLE™ BARREL**

**CONSTRUCTION:**  
Continuous taper design with Paraflex™ Composite Handle.

**90 WARRANTY:**  
Corndog™ Wood Composite includes a 90 day warranty.



UPRISING®	2 1/4"	[34"/26] [34"/27] [34"/28]	WBD2238010	MSRP: \$99.99
-----------	--------	----------------------------	------------	---------------

**DX1™ ALLOY BARREL:**  
High strength alloy built for performance.

**CONSTRUCTION:**  
Single wall construction.



**BUILT FOR**  
THE GAME'S  
BIGGEST STAGE  
This is Cody Bellinger's CB35

*Cody Bellinger signature*

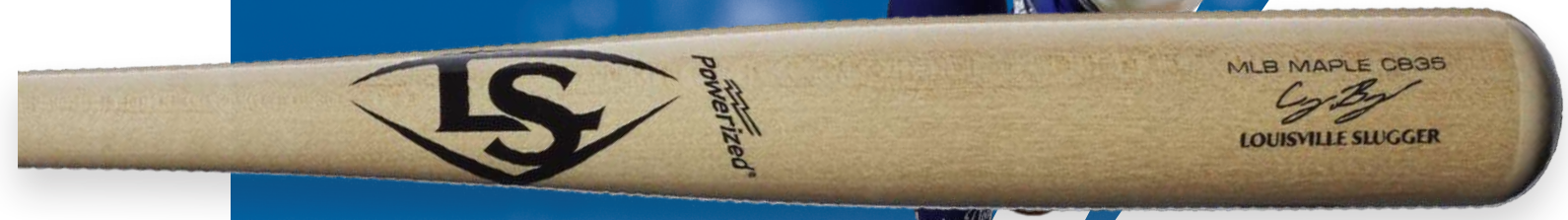

**CODY BELLINGER SIGNATURE SERIES CB35**



# THE DIFFERENCE IS IN THE DETAILS



## KNOB MEDALLION

Easy-to-read medallions have been embedded in the knob and indicate the MLB® Prime® grade of wood, species and length, while the bat name is engraved in the surrounding area.

## EXOPRO FINISH

The MLB® Prime® lineup features the revolutionary EXOPRO finish that's twice as hard as the previous EXOARMOR®. This innovation in wood bat technology gives you a finish you can feel in an incredibly durable top coat that not only drastically increases surface hardness, but gives you a mirror-like finish in high-gloss models.



## SEAMLESS DECALS

Louisville Slugger's exclusive Seamless Decals are applied directly under the top coat, giving MLB® Prime® bats a pristine look. All MLB Prime models feature branding that blends into the bat almost as intricately as the grain of the wood.

## CRAFTSMAN-STYLE CUP

Our completely re-engineered Craftsman-Style Cup features a thicker width edge along the end of the barrel, lending added strength and durability to the end of the bat to help reduce chipping and cracking.

## 30-DAY LIMITED WARRANTY

All MLB® Prime® bats come with a 30-day limited warranty. Restrictions apply. Visit [Slugger.com](http://Slugger.com) for complete details.

## WOOD SPECIES

Louisville Slugger is dedicated to crafting wood bats perfect for each player. We offer three wood species: Maple, Ash and Birch. So no matter how you like your lumber, the team at Louisville Slugger has you covered.



### MAPLE

The dominant wood species in Major League Baseball, Maple bats are known for their surface hardness, stiffer feel and unmatched sound.



### ASH

The original wood species in Major League Baseball, Ash bats are generally lighter than other species and have a lighter weight feel and more flexibility upon contact.



### BIRCH

One of the newer, but fastest growing wood species in Major League Baseball, Birch bats feature a surface hardness close to that of maple but increased flexibility.

## SWING WEIGHT SCALE

Everyone talks about the length and weight of their baseball bat. But swing weight might be one of the most impactful ways to classify bats. Swing weight is a determination of how a bat's weight is distributed along its length. More weight toward the end of the barrel means you're swinging an end-loaded bat. These models create more momentum in a player's swing and generate more power and distance. Evenly distributed weight in balanced bats allow for a potentially greater swing speed for many hitters – perfect for players who focus on bat control and increased contact.



## MLB® PRIME® SIGNATURE SERIES BATS



<b>CY22—CHRISTIAN YELICH</b>		WBL2435010	MSRP: \$149.95
		<b>SWING WEIGHT:</b> 4 [SLIGHTLY END LOADED]	<b>FINISH:</b> BLACK
			<b>IN:</b> [31"] [32"] [33"] [34"]
<b>WOOD:</b> MLB® MAPLE	<b>TURNING MODEL:</b> CY22	<b>TOP COAT:</b> EXOPRO—PRO HARDCOAT	<b>INK DOT:</b> YES
			<b>BONE RUBBED:</b> YES
			<b>CUPPED:</b> YES



<b>CB35—CODY BELLINGER</b>		WBL2437010	MSRP: \$149.95
		<b>SWING WEIGHT:</b> 4 [SLIGHTLY END LOADED]	<b>FINISH:</b> NATURAL
			<b>IN:</b> [31"] [32"] [33"] [33.5"] [34"]
<b>WOOD:</b> MLB® MAPLE	<b>TURNING MODEL:</b> CB35	<b>TOP COAT:</b> EXOPRO—PRO HARDCOAT	<b>INK DOT:</b> YES
			<b>BONE RUBBED:</b> YES
			<b>CUPPED:</b> NO



<b>RA13—RONALD ACUÑA JR.</b>		WBL2436010	MSRP: \$149.95
		<b>SWING WEIGHT:</b> 4 [SLIGHTLY END LOADED]	<b>FINISH:</b> HARDLINE (BLACK TAPE) BLACK TO NATURAL
			<b>IN:</b> [31"] [32"] [33"] [33.5"] [34"]
<b>WOOD:</b> MLB® MAPLE	<b>TURNING MODEL:</b> RA13	<b>TOP COAT:</b> EXOPRO—PRO HARDCOAT	<b>INK DOT:</b> YES
			<b>BONE RUBBED:</b> YES
			<b>CUPPED:</b> YES



<b>VG27—VLADIMIR GUERRERO JR.</b>		WBL2440010	MSRP: \$149.95
		<b>SWING WEIGHT:</b> 4 [SLIGHTLY END LOADED]	<b>FINISH:</b> NATURAL
			<b>IN:</b> [31"] [32"] [33"] [34"]
<b>WOOD:</b> MLB® BIRCH	<b>TURNING MODEL:</b> VG27	<b>TOP COAT:</b> EXOPRO—PRO HARDCOAT	<b>INK DOT:</b> YES
			<b>BONE RUBBED:</b> YES
			<b>CUPPED:</b> NO



## MLB® PRIME® SIGNATURE SERIES BATS



<b>EJ74-ELOY JIMENEZ</b>		WBL2438010	MSRP: \$149.95
		<b>SWING WEIGHT:</b> 4 [SLIGHTLY END LOADED]	<b>FINISH:</b> HARDLINE (SILVER TAPE) NATURAL TO BLACK
<b>WOOD:</b> MLB® MAPLE		<b>TURNING MODEL:</b> EJ74	<b>TOP COAT:</b> EXOPRO-PRO HARDCOAT
		<b>INK DOT:</b> YES	<b>BONE RUBBED:</b> YES
		<b>CUPPED:</b> YES	



<b>KS12-KYLE SCHWARBER</b>		WBL2439010	MSRP: \$149.95
		<b>SWING WEIGHT:</b> 4 [SLIGHTLY END LOADED]	<b>FINISH:</b> HARDLINE (BLACK TAPE) MATTE BLACK TO NATURAL
<b>WOOD:</b> MLB® MAPLE		<b>TURNING MODEL:</b> KS12	<b>TOP COAT:</b> EXOPRO-PRO HARDCOAT
		<b>INK DOT:</b> YES	<b>BONE RUBBED:</b> YES
		<b>CUPPED:</b> YES	

## PRIME® MAPLE



<b>C271-HIGH ROLLER</b>		WTLWPM271D20	MSRP: \$149.95
		<b>SWING WEIGHT:</b> 1 [MOST BALANCED]	<b>FINISH:</b> FADE - DEEP FLAME TO DISTRESSED BLACK
<b>WOOD:</b> MLB® MAPLE		<b>TURNING MODEL:</b> C271	<b>TOP COAT:</b> EXOPRO-PRO HARDCOAT
		<b>INK DOT:</b> YES	<b>BONE RUBBED:</b> YES
		<b>CUPPED:</b> YES	



<b>C271L-LOYALIST</b>		WBL2432010	MSRP: \$149.95
		<b>SWING WEIGHT:</b> 2 [MORE BALANCED]	<b>FINISH:</b> GRAY STAIN
<b>WOOD:</b> MLB® MAPLE		<b>TURNING MODEL:</b> C271L	<b>TOP COAT:</b> EXOPRO-PRO HARDCOAT
		<b>INK DOT:</b> YES	<b>BONE RUBBED:</b> YES
		<b>CUPPED:</b> YES	

## MLB® PRIME® MAPLE



<b>DJ2-CAPTAIN</b>		WTLWPMDJ2A20	MSRP: \$149.95
		<b>SWING WEIGHT:</b> 3 [SLIGHTLY BALANCED]	<b>FINISH:</b> HARDLINE (SILVER TAPE) NAVY TO GRAY STAIN
<b>WOOD:</b> MLB® MAPLE		<b>TURNING MODEL:</b> DJ2	<b>TOP COAT:</b> EXOPRO-PRO HARDCOAT
		<b>INK DOT:</b> YES	<b>BONE RUBBED:</b> YES
		<b>CUPPED:</b> YES	



<b>U47-WARRIOR</b>		WBL2433010	MSRP: \$149.95
		<b>SWING WEIGHT:</b> 3 [SLIGHTLY BALANCED]	<b>FINISH:</b> FADE - DEEP FLAME TO CRAWFORD BLEND
<b>WOOD:</b> MLB® MAPLE		<b>TURNING MODEL:</b> U47	<b>TOP COAT:</b> EXOPRO-PRO HARDCOAT
		<b>INK DOT:</b> YES	<b>BONE RUBBED:</b> YES
		<b>CUPPED:</b> YES	



<b>I13-DRIP</b>		WTLWPMI13A20	MSRP: \$149.95
		<b>SWING WEIGHT:</b> 4 [SLIGHTLY END LOADED]	<b>FINISH:</b> FADE - MATTE BLACK TO MATTE GOLD
<b>WOOD:</b> MLB® MAPLE		<b>TURNING MODEL:</b> I13	<b>TOP COAT:</b> EXOPRO-PRO HARDCOAT
		<b>INK DOT:</b> YES	<b>BONE RUBBED:</b> YES
		<b>CUPPED:</b> YES	

## PRIME® BIRCH



<b>M110-PENNIES</b>		WBL2434010	MSRP: \$149.95
		<b>SWING WEIGHT:</b> 1 [MOST BALANCED]	<b>FINISH:</b> FADE - BLACK TO COPPER PEARL
<b>WOOD:</b> MLB® BIRCH		<b>TURNING MODEL:</b> M110	<b>TOP COAT:</b> EXOPRO-PRO HARDCOAT
		<b>INK DOT:</b> YES	<b>BONE RUBBED:</b> YES
		<b>CUPPED:</b> YES	



### SELECT CUT



<b>MAPLE C271</b>		WTLW7M271A20	MSRP: \$99.99	
	SWING WEIGHT: 1 [MOST BALANCED]	FINISH: NATURAL	IN: [31"] [32"] [33"] [34"]	
WOOD: SERIES 7 MAPLE	TURNING MODEL: C271	TOP COAT: EXOPRO-PRO HARDCOAT	BONE RUBBED: YES	CUPPED: YES



<b>MAPLE C243</b>		WTLW7M243A20	MSRP: \$99.99	
	SWING WEIGHT: 4 [SLIGHTLY END LOADED]	FINISH: BLACK	IN: [31"] [32"] [33"] [34"]	
WOOD: SERIES 7 MAPLE	TURNING MODEL: C243	TOP COAT: EXOPRO-PRO HARDCOAT	BONE RUBBED: YES	CUPPED: YES



<b>BIRCH C271</b>		WTLW7B271A20	MSRP: \$99.99	
	SWING WEIGHT: 1 [MOST BALANCED]	FINISH: HORNSBY	IN: [31"] [32"] [33"] [34"]	
WOOD: SERIES 7 BIRCH	TURNING MODEL: C271	TOP COAT: EXOPRO-PRO HARDCOAT	BONE RUBBED: YES	CUPPED: YES



<b>ASH C271</b>		WTLW7A271A20	MSRP: \$99.99	
	SWING WEIGHT: 1 [MOST BALANCED]	FINISH: NATURAL	IN: [31"] [32"] [33"] [34"]	
WOOD: SERIES 7 ASH	TURNING MODEL: C271	TOP COAT: EXOPRO-PRO HARDCOAT	BONE RUBBED: YES	CUPPED: YES



### LEGACY



<b>M9 C271</b>		WTLW5M271A18	MSRP: \$84.99	
	SWING WEIGHT: 1 [MOST BALANCED]	FINISH: NATURAL	IN: [31"] [32"] [33"] [34"]	
WOOD: SERIES 5 MAPLE	TURNING MODEL: C271	TOP COAT: REGULAR GLOSS	BONE RUBBED: YES	CUPPED: YES



<b>M9 C243</b>		WTLW5M243A18	MSRP: \$84.99	
	SWING WEIGHT: 4 [SLIGHTLY END LOADED]	FINISH: MATTE BLACK	IN: [32"] [33"] [34"]	
WOOD: SERIES 5 MAPLE	TURNING MODEL: C243	TOP COAT: REGULAR MATTE	BONE RUBBED: YES	CUPPED: YES



<b>B9 MIXED</b>		WTLW5BMIXA18	MSRP: \$84.99	
	SWING WEIGHT: MIXED	FINISH: BLACK	IN: [32"] [33"] [34"]	
WOOD: SERIES 5 BIRCH	TURNING MODEL: MIXED	TOP COAT: REGULAR GLOSS	BONE RUBBED: YES	CUPPED: YES



<b>M110</b>		WTLW5A110A16	MSRP: \$54.99	
	SWING WEIGHT: 1 [MOST BALANCED]	FINISH: FADE-UNFINISHED TO FLAME	IN: [32"] [33"] [34"]	
WOOD: SERIES 5 ASH	TURNING MODEL: M110	TOP COAT: REGULAR GLOSS	BONE RUBBED: NO	CUPPED: YES



<b>C271</b>		WTLW5A271A16	MSRP: \$54.99	
	SWING WEIGHT: 1 [MOST BALANCED]	FINISH: NATURAL	IN: [32"] [33"] [34"]	
WOOD: SERIES 5 ASH	TURNING MODEL: C271	TOP COAT: REGULAR GLOSS	BONE RUBBED: NO	CUPPED: YES



## LEGACY



C243		WTLW5A243A16	MSRP: \$54.99	
		SWING WEIGHT: 4 [SLIGHTLY END LOADED]	FINISH: MATTE BLACK	IN: [32"] [33"] [34"]
WOOD: SERIES 5 ASH	TURNING MODEL: C243	TOP COAT: REGULAR MATTE		BONE RUBBED: NO CUPPED: YES

## LEGACY LTE



C243		WTLW5A243B16	MSRP: \$54.99	
		SWING WEIGHT: 4 [SLIGHTLY END LOADED]	FINISH: HORNSBY	IN: [32"] [33"] [34"]
WOOD: SERIES 5 LTE ASH GUARANTEED -30Z	TURNING MODEL: C243	TOP COAT: REGULAR GLOSS		BONE RUBBED: NO CUPPED: YES



C271		WTLW5A271C16	MSRP: \$54.99	
		SWING WEIGHT: 1 [MOST BALANCED]	FINISH: BLACK	IN: [29"] [30"] [31"] [32"]
WOOD: SERIES 5 LTE ASH GUARANTEED -50Z	TURNING MODEL: C271	TOP COAT: REGULAR GLOSS		BONE RUBBED: NO CUPPED: YES



T141		WTLW5A141A16	MSRP: \$54.99	
		SWING WEIGHT: 1 [MOST BALANCED]	FINISH: HARDLINE [BLACK TAPE] BLACK TO NATURAL	IN: [30"] [31"] [32"]
WOOD: SERIES 5 LTE ASH GUARANTEED -50Z	TURNING MODEL: T141	TOP COAT: REGULAR GLOSS		BONE RUBBED: NO CUPPED: YES



## GENUINE™



M110		WTLW3M110A17	MSRP: \$54.99	
		SWING WEIGHT: 1 [MOST BALANCED]	FINISH: HARDLINE [WHITE TAPE] NATURAL TO PINK	IN: [31"] [32"] [33"] [34"]
WOOD: SERIES 3 MAPLE	TURNING MODEL: M110	TOP COAT: REGULAR		BONE RUBBED: NO CUPPED: YES



M110		WTLW3M110B20	MSRP: \$54.99	
		SWING WEIGHT: 1 [MOST BALANCED]	FINISH: HARDLINE [WHITE TAPE] NATURAL TO BLUE	IN: [31"] [32"] [33"] [34"]
WOOD: SERIES 3 MAPLE	TURNING MODEL: M110	TOP COAT: REGULAR		BONE RUBBED: NO CUPPED: YES



C271		WTLW3M271A16	MSRP: \$54.99	
		SWING WEIGHT: 1 [MOST BALANCED]	FINISH: BLACK	IN: [30"] [31"] [32"] [33"] [34"]
WOOD: SERIES 3 MAPLE	TURNING MODEL: C271	TOP COAT: REGULAR		BONE RUBBED: NO CUPPED: YES



I13		WTLW3M113A16	MSRP: \$54.99	
		SWING WEIGHT: 4 [SLIGHTLY END LOADED]	FINISH: HARDLINE [BLACK TAPE] BLACK TO NATURAL	IN: [32"] [33"] [34"]
WOOD: SERIES 3 MAPLE	TURNING MODEL: I13	TOP COAT: REGULAR		BONE RUBBED: NO CUPPED: YES



### GENUINE™



MIXED			WTLW3AMIXA16	MSRP: \$44.99
		FINISH: HARDLINE [BLACK TAPE] BLACK TO NATURAL	IN: [31"] [32"] [33"] [34"]	
WOOD: SERIES 3 MIXED	TURNING MODEL: MIXED	TOP COAT: REGULAR	BONE RUBBED: NO	CUPPED: YES



MIXED			WTLW3AMIXB16	MSRP: \$34.99
		FINISH: NATURAL	IN: [31"] [32"] [33"] [34"]	
WOOD: SERIES 3X MIXED	TURNING MODEL: MIXED	TOP COAT: REGULAR	BONE RUBBED: NO	CUPPED: YES



MIXED			WTLW3AMIXC16	MSRP: \$34.99
		FINISH: BLACK	IN: [31"] [32"] [33"] [34"]	
WOOD: SERIES 3X MIXED	TURNING MODEL: MIXED	TOP COAT: REGULAR	BONE RUBBED: NO	CUPPED: YES



### YOUTH PRIME®



Y271			WTLWYM271A20	MSRP: \$74.95
		TARGET DROP: -8 (+/- 20Z)	FINISH: NATURAL	IN: [27"] [28"] [29"] [30"] [31"]
WOOD: YTH PRIME® MAPLE	TURNING MODEL: Y271	TOP COAT: EXOPRO-PRO HARDCOAT	BONE RUBBED: NO	CUPPED: YES



Y271			WTLWYM271C20	MSRP: \$74.95
		TARGET DROP: -8 (+/- 20Z)	FINISH: FADE – DEEP FLAME TO DISTRESSED BLACK	IN: [27"] [28"] [29"] [30"] [31"]
WOOD: YTH PRIME® MAPLE	TURNING MODEL: Y271	TOP COAT: EXOPRO-PRO HARDCOAT	BONE RUBBED: NO	CUPPED: YES



Y318-BIG BARREL			WBL2441010	MSRP: \$74.95
		TARGET DROP: -6 (+/- 20Z)	FINISH: BLACK	IN: [27"] [28"] [29"] [30"] [31"]
WOOD: YTH PRIME® MAPLE	TURNING MODEL: Y318	TOP COAT: EXOPRO-PRO HARDCOAT	BONE RUBBED: NO	CUPPED: YES



Y318-BIG BARREL			WBL2441020	MSRP: \$74.95
		TARGET DROP: -6 (+/- 20Z)	FINISH: HARDLINE (WHITE TAPE) NATURAL TO GRAY STAIN	IN: [27"] [28"] [29"] [30"] [31"]
WOOD: YTH PRIME® MAPLE	TURNING MODEL: Y318	TOP COAT: EXOPRO-PRO HARDCOAT	BONE RUBBED: NO	CUPPED: YES



### YOUTH LEGACY



Y243		WTLWYM243A20	MSRP: \$44.99	
		FINISH: HARDLINE [GOLD TAPE] NATURAL TO WINE		IN: [27"] [28"] [29"] [30"] [31"]
WOOD: YTH MAPLE	TURNING MODEL: Y243	TOP COAT: REGULAR	BONE RUBBED: NO	CUPPED: YES

### YOUTH FLYLITE



Y243		WTLWYF243A20	MSRP: \$34.99	
		TARGET DROP: -10 (+/- 20Z)	FINISH: NAVY	IN: [27"] [28"] [29"] [30"]
WOOD: YTH POPLAR	TURNING MODEL: Y243	TOP COAT: REGULAR	BONE RUBBED: NO	CUPPED: YES



Y243		WTLWYF243B20	MSRP: \$34.99	
		TARGET DROP: -10 (+/- 20Z)	FINISH: DARK GRAY	IN: [27"] [28"] [29"] [30"]
WOOD: YTH POPLAR	TURNING MODEL: Y243	TOP COAT: REGULAR	BONE RUBBED: NO	CUPPED: YES



### YOUTH GENUINE™



125		WTLWYM125A20	MSRP: \$29.99	
		FINISH: BLACK		IN: [27"] [28"] [29"] [30"] [31"]
WOOD: YTH 125 MAPLE	TURNING MODEL: YTH 125	TOP COAT: REGULAR	BONE RUBBED: NO	CUPPED: YES



125		WBL2442010	MSRP: \$29.99	
		FINISH: HARDLINE – BLACK TO NATURAL		IN: [27"] [28"] [29"] [30"] [31"]
WOOD: YTH 125 MAPLE	TURNING MODEL: YTH 125	TOP COAT: REGULAR	BONE RUBBED: NO	CUPPED: YES



125		WTLWYA125A20	MSRP: \$24.99	
		FINISH: BLACK		IN: [27"] [28"] [29"] [30"]
WOOD: YTH 125 ASH	TURNING MODEL: YTH 125	TOP COAT: REGULAR	BONE RUBBED: NO	CUPPED: YES



YOUTH TEE BALL		WTLWYATEEA1626	MSRP: \$24.99	
		FINISH: NATURAL		IN: [26"]
WOOD: YTH ASH	TURNING MODEL: TEE BALL	TOP COAT: REGULAR	BONE RUBBED: NO	CUPPED: YES



### PRIME® FUNGO



<b>S345</b>		WBL2443010		MSRP: \$74.99
WOOD: MAPLE	TURNING MODEL: S345	TOP COAT: EXOPRO-PRO HARDCOAT	FINISH: FADE – BLACK / SILVER	IN: [35"]



<b>S345</b>		WBL2443020		MSRP: \$74.99
WOOD: MAPLE	TURNING MODEL: S345	TOP COAT: EXOPRO-PRO HARDCOAT	FINISH: FADE – BLACK / ROYAL	IN: [35"]



<b>S345</b>		WBL2443030		MSRP: \$74.99
WOOD: MAPLE	TURNING MODEL: S345	TOP COAT: EXOPRO-PRO HARDCOAT	FINISH: FADE – BLACK / YELLOW	IN: [35"]



<b>G160</b>		WBL2444010		MSRP: \$74.99
WOOD: MAPLE	TURNING MODEL: G160	TOP COAT: EXOPRO-PRO HARDCOAT	FINISH: FADE – BLACK / GOLD	IN: [36"]



<b>G160</b>		WBL2444020		MSRP: \$74.99
WOOD: MAPLE	TURNING MODEL: G160	TOP COAT: EXOPRO-PRO HARDCOAT	FINISH: FADE – BLACK / RED	IN: [36"]



<b>G160</b>		WBL2444030		MSRP: \$74.99
WOOD: MAPLE	TURNING MODEL: G160	TOP COAT: EXOPRO-PRO HARDCOAT	FINISH: BLACK	IN: [36"]



### FLYLITE FUNGO



<b>MB37</b>		WTLWFMB37A20		MSRP: \$74.95
WOOD: POPLAR		TURNING MODEL: MB37	TOP COAT: EXOPRO-PRO HARDCOAT	TARGET DROP: -12 (+/- 20Z)
FINISH: BLACK			IN: [37"]	



<b>MB37</b>		WTLWFMB37B20		MSRP: \$74.95
WOOD: POPLAR		TURNING MODEL: MB37	TOP COAT: EXOPRO-PRO HARDCOAT	TARGET DROP: -12 (+/- 20Z)
FINISH: NAVY			IN: [37"]	



<b>K100</b>		WTLWBFN100		MSRP: \$34.99
WOOD: ASH		FINISH: NATURAL		TURNING MODEL: K100
IN: [36"]				





## TRAINING



FULL SIZE HEAVY TRAINING BAT	WTLWBTRHVV-OR	MSRP: \$54.99
	WEIGHT: 43-44 oz.	WOOD: ASH
VERSATILE 5-IN-1 WEIGHTED TRAINING BAT		



ONE-HANDED TRAINING BAT	WTLWBTR1HT-BK	MSRP: \$44.99
	WOOD: ASH	IN: [18"]
SHORT BAT WITH REGULATION BARREL		

## SLOWPITCH



ADULT SLOWPITCH	WTLWSMSB3A20	MSRP: \$34.99
	FINISH: GRAY STAIN	IN: [34"]
WOOD: MAPLE	TURNING MODEL: MSB3	TOP COAT: REGULAR GLOSS
CUPPED: NO		



# TAKE ONE FOR YOUR TEAM.

Go to bat for your favorite Major League club with Louisville Slugger® mini MLB® bats. Each of these 18" wood bats are outfitted with the colors and logo of the MLB® team of your choice.

MSRP: \$12.99/EA

- WTLWT2MLBBALTC: BALTIMORE ORIOLES
- WTLWT2MLBBOSTC: BOSTON RED SOX
- WTLWT2MLBCHWTC: CHICAGO WHITE SOX
- WTLWT2MLBCLCETC: CLEVELAND INDIANS
- WTLWT2MLBDETTTC: DETROIT TIGERS
- WTLWT2MLBHOUTC: HOUSTON ASTROS
- WTLWT2MLBKCTC: KANSAS CITY ROYALS
- WTLWT2MLBLAATC: LOS ANGELES ANGELS
- WTLWT2MLBMINTC: MINNESOTA TWINS
- WTLWT2MLBNYYTC: NEW YORK YANKEES
- WTLWT2MLBOAKTC: OAKLAND ATHLETICS
- WTLWT2MLBSEATC: SEATTLE MARINERS
- WTLWT2MLBTBTC: TAMPA BAY RAYS
- WTLWT2MLBTEXTC: TEXAS RANGERS
- WTLWT2MLBTORTC: TORONTO BLUE JAYS
- WTLWT2MLBARITC: ARIZONA DIAMONDBACKS
- WTLWT2MLBATLTC: ATLANTA BRAVES
- WTLWT2MLBCHCTC: CHICAGO CUBS
- WTLWT2MLBCINTC: CINCINNATI REDS
- WTLWT2MLBCOLTC: COLORADO ROCKIES
- WTLWT2MLBLADTC: LOS ANGELES DODGERS
- WTLWT2MLBIATC: MIAMI MARLINS
- WTLWT2MLBMILTC: MILWAUKEE BREWERS
- WTLWT2MLBNYMTTC: NEW YORK METS
- WTLWT2MLBPHITC: PHILADELPHIA PHILLIES
- WTLWT2MLBPITTC: PITTSBURGH PIRATES
- WTLWT2MLBSDTC: SAN DIEGO PADRES
- WTLWT2MLBSFTC: SAN FRANCISCO GIANTS
- WTLWT2MLBSTLTC: ST. LOUIS CARDINALS
- WTLWT2MLBSHTC: WASHINGTON NATIONALS



2022

SECTION BRANDS

EVOSHIELD  
WILSON

CATCHER'S GEAR

# CATCHER'S GEAR

## WELCOME TO THE MOST ADVANCED CATCHER'S GEAR EVER.

GO TO BATTLE WITH THE ONLY CUSTOM-MOLDED CATCHER'S PROTECTION IN THE GAME TODAY.



HELMET  
OR  
SKULLCAP & FACEMASK

CHEST PROTECTOR

UPPER LEG GUARDS

LOWER LEG GUARDS



### PRO-SRZ™ LEG GUARD SYSTEM

THE MOST ADVANCED LEG GUARD SYSTEM IN THE GAME

Shape the future with the EvoShield PRO-SRZ™ Catcher's Leg Guard System. Designed with the same Gel-to-Shell® innovation players love at the plate, this cutting-edge two-piece system guarantees unparalleled comfort and protection. To complete the leg guard system (each piece sold separately), attach the PRO-SRZ™ Upper Leg Guard to the custom-molded PRO-SRZ™ Lower Leg Guard.

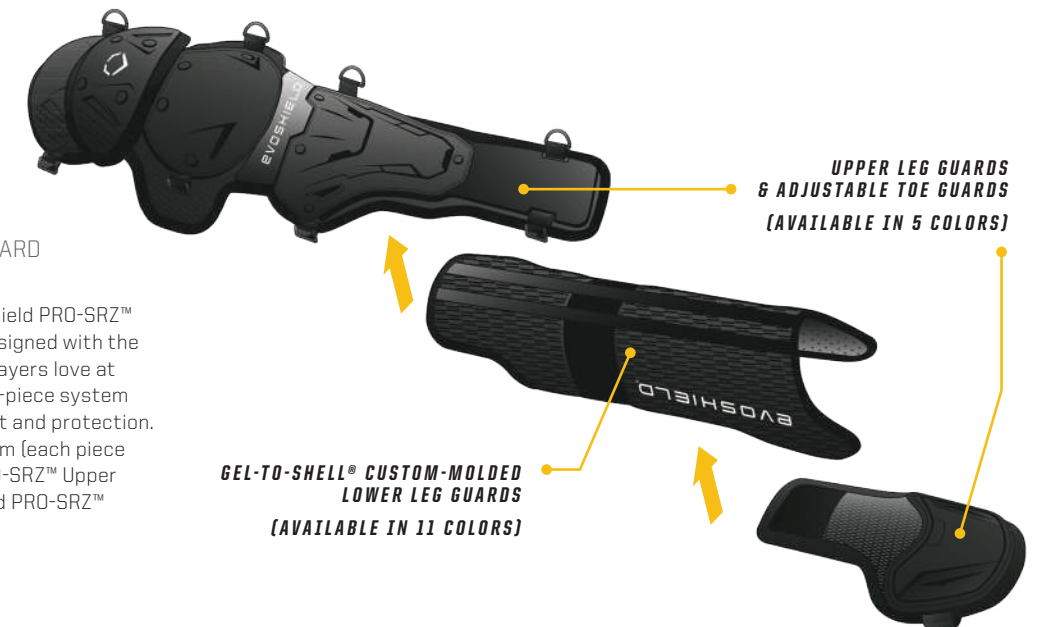

UPPER LEG GUARDS & ADJUSTABLE TOE GUARDS  
(AVAILABLE IN 5 COLORS)

GEL-TO-SHELL® CUSTOM-MOLDED LOWER LEG GUARDS  
(AVAILABLE IN 11 COLORS)



## PRO-SRZ™ BASEBALL

### PRO-SRZ™ BASEBALL CHEST PROTECTOR



ARTICLE (ADULT)	ARTICLE (INTERMEDIATE)	COLOR	MAP (ADULT)	MAP (INTERMEDIATE)
WB5709201	WB5709301	Black	\$199.95	\$179.95
WB5709202	WB5709302	Charcoal		
WB5709203	WB5709303	Navy		
WB5709204	WB5709304	Royal		
WB5709205	WB5709305	Scarlet		

#### SIZES

ADULT 16" // INTERMEDIATE 15"

**FIDLOCK® BUCKLE** Strong magnetic design with slide release allows for easy on/off

**MOLDABLE ABDOMINAL WIRE** Adjustable custom fit keeps chest protector in place

**NOCSAE® PROTECTIVE CHEST GUARD** Built-in/Removable pocket houses NOCSAE® Chest Guard



### NOCSAE® PROTECTIVE CHEST GUARD

ARTICLE  
WB5708701

**SAS-TEC™ GUARD** extremely light-weight and durable protection

This chest guard is certified by SEI to meet the NOCSAE® standard for protection against Commotio Cordis. NOCSAE® protective chest guard MUST be worn with this catcher's chest protector for the chest protector to adhere to NOCSAE® standards and regulations.



### PRO-SRZ™ BASEBALL UPPER LEG GUARDS



ARTICLE (ADULT)	ARTICLE (INTERMEDIATE)	COLOR	MAP (ADULT)	MAP (INTERMEDIATE)
WB5707901	WB5709401	Black	\$134.95	\$124.95
WB5707902	WB5709402	Charcoal		
WB5707903	WB5709403	Navy		
WB5707904	WB5709404	Royal		
WB5707905	WB5709405	Scarlet		

#### SIZES

ADULT 15.5-17.5" // INTERMEDIATE 13.5-15.5"

**ADJUSTABLE LENGTH** Guard can be lengthened or shortened 2" for custom fit

**STAYS IN PLACE** Reinforced knee and thigh construction keeps gear in place

**ENHANCED KNEE SUPPORT** Adjustable knee pad engineered with comfort foam

**TWO PIECE LEG GUARD SYSTEM** Requires PRO-SRZ™ Lower Leg Guards



### PRO-SRZ™ LOWER LEG GUARDS



ARTICLE (ADULT)	ARTICLE (INTERMEDIATE)	COLOR	MAP (ADULT)	MAP (INTERMEDIATE)
WB5708001	WB5710301	Black	\$154.95	\$144.95
WB5708002	WB5710302	Charcoal		
WB5708003	WB5710303	Dark Green		
WB5708004	WB5710304	Maroon		
WB5708005	WB5710305	Navy		
WB5708006	WB5710306	Orange		
WB5708007	WB5710307	Purple		
WB5708008	WB5710308	Royal		
WB5708009	WB5710309	Scarlet		
WB5708010	WB5710310	White		
WB5708011	WB5710311	Yellow		

#### SIZES

ADULT 15.5-17.5" // INTERMEDIATE 13.5-15.5"

**GEL-TO-SHELL® TECHNOLOGY** Begins soft and flexible, transforms to hard and protective in minutes

**DISPERSION TECHNOLOGY** Spreads the force across the surface of the shield, minimizing felt impact

**ERGONOMIC GUARD SHAPE** with Gel-to-Shell® technology allow you to create a fully custom guard for protection behind the plate

**TWO PIECE LEG GUARD SYSTEM** Requires PRO-SRZ™ Upper Leg Guards



## PRO-SRZ™ FASTPITCH

### PRO-SRZ™ FASTPITCH CHEST PROTECTOR



ARTICLE (ADULT)	ARTICLE (INTERMEDIATE)	COLOR	MAP (ADULT)	MAP (INTERMEDIATE)
WB5709001	WB5709101	Black	\$199.95	\$179.95
WB5709002	WB5709102	Charcoal		
WB5709003	WB5709103	Navy		
WB5709004	WB5709104	Royal		
WB5709005	WB5709105	Scarlet		

#### SIZES

ADULT 15" // INTERMEDIATE 13.5"

**FIDLOCK® BUCKLE** Strong magnetic design with slide release allows for easy on/off

**MOLDABLE ABDOMINAL WIRE** Adjustable custom fit keeps chest protector in place

**FEMALE DESIGN PATTERN** Built and cut to be the most comfortable designed gear for the ladies protecting the plate

### PRO-SRZ™ FASTPITCH UPPER LEG GUARDS



ARTICLE (FASTPITCH)	COLOR	MAP (FASTPITCH)
WB5708101	Black	\$124.95
WB5708102	Charcoal	
WB5708103	Navy	
WB5708104	Royal	
WB5708105	Scarlet	

#### SIZES

FASTPITCH 13.5-15.5"

**ADJUSTABLE LENGTH** Guard can be lengthened or shortened 2" for custom fit

**STAYS IN PLACE** Reinforced knee and thigh construction keeps gear in place

**ENHANCED KNEE SUPPORT** Adjustable knee pad engineered with comfort foam

**TWO PIECE LEG GUARD SYSTEM** Requires PRO-SRZ™ Lower Leg Guards

### PRO-SRZ™ LOWER LEG GUARDS



ARTICLE (FASTPITCH)	COLOR	MAP (FASTPITCH)
WB5710301	Black	\$144.95
WB5710302	Charcoal	
WB5710303	Dark Green	
WB5710304	Maroon	
WB5710305	Navy	
WB5710306	Orange	
WB5710307	Purple	
WB5710308	Royal	
WB5710309	Scarlet	
WB5710310	White	
WB5710311	Yellow	

#### SIZES

FASTPITCH 13.5-15.5"

**GEL-TO-SHELL® TECHNOLOGY** Begins soft and flexible, transforms to hard and protective in minutes

**DISPERSION TECHNOLOGY** Spreads the force across the surface of the shield, minimizing felt impact

**ERGONOMIC GUARD SHAPE** with Gel-to-Shell® technology allow you to create a fully custom guard for protection behind the plate

**TWO PIECE LEG GUARD SYSTEM** Requires PRO-SRZ™ Upper Leg Guards





## PRO-SRZ™ BASEBALL & FASTPITCH

### PRO-SRZ™ CATCHER'S HELMET

ARTICLE	COLOR	MAP
WB5708401	Black	\$289.95
WB5708402	Charcoal	
WB5708403	Navy	
WB5708404	Royal	
WB5708405	Scarlet	

#### SIZES

SMALL [6½- 7], MEDIUM [7-7½], LARGE [7½-8]

**SHOCK ABSORBING PADDING SYSTEM** Windpact's Crash Cloud® technology absorbs and disperses impact energy, giving you greater protection and comfort

**ENGINEERED FOR PERFORMANCE** Durable steel facemask engineered for maximum field of vision and enhanced impact protection

**GLOSSY FINISH** Two-Tone color, light weight ABS shell

**MEETS NOCSAE® STANDARD** This helmet is certified by SEI to meet the NOCSAE® standard for baseball/softball catcher's helmets



BL

### NEW PRO-SRZ™ CATCHER'S HELMET SOLID

ARTICLE	COLOR	MAP
WB5720101	Black	\$189.95
WB5720102	Charcoal	
WB5720103	Navy	
WB5720104	Royal	
WB5720105	Scarlet	

#### SIZES

S/M [6¼-7], L/XL [7 - 7¾]

**COMFORT PADDING SYSTEM** Foam padding absorbs and disperses impact energy, giving you greater protection and comfort

**ENGINEERED FOR PERFORMANCE** Durable steel facemask engineered for maximum field of vision and enhanced impact protection

**GLOSSY FINISH** Single color, light weight ABS shell

**MEETS NOCSAE® STANDARD** This helmet is certified by SEI to meet the NOCSAE® standard for baseball/softball catcher's helmets



BL

### PRO-SRZ™ CATCHER'S FACEMASK

ARTICLE	COLOR	MAP
WB5708501	Black	\$129.95
WB5708502	Charcoal	
WB5708503	Navy	
WB5708504	Royal	
WB5708505	Scarlet	

#### SIZES

ONE SIZE

**SHOCK ABSORBING PADDING SYSTEM** Windpact's Crash Cloud® technology absorbs and disperses impact energy, giving you greater protection and comfort

**ENGINEERED FOR PERFORMANCE** Durable steel facemask engineered for maximum field of vision and enhanced impact protection

**NO-SLIP HARNESS** Adjustable neoprene harness designed to hold mask in place



BL



## PRO-SRZ™ BASEBALL & FASTPITCH

### PRO-SRZ™ SKULL CAP

ARTICLE	COLOR	MSRP
WB5708601	Black	\$34.95
WB5708602	Charcoal	
WB5708603	Navy	
WB5708604	Royal	
WB5708605	Scarlet	

#### SIZES

L/XL [7¾ and above], S/M [7¼ and below]

COMFORT FOAM PADDING

SEMI-GLOSS FINISH

TWO SIZES FIT MOST



### NEW CATCHER'S KNEE BLOCKS

ARTICLE	COLOR	MSRP
WB5718901	Black	\$39.95

#### SIZES

ADULT

**2 INCH ADJUSTABLE RIDE HEIGHT** Change your support height, unzip the pocket, remove foam wedge to adjust to your preferred height

**USER-FRIENDLY DESIGN** Simply slide your straps securely through the loops, no adjustments needed. No more taking apart your leg guards just to adjust your knee support

**PREMIUM CONSTRUCTION** Top of the line materials with no hard plastic or metal attachments, designed to contour to your body and maximize comfort behind the plate

**BUILT FOR THE PRO-SRZ CATCHER'S LEG GUARD SYSTEM** Compatible with most catcher's leg guards



Shown with ProSRZ™ Catcher's Leg Guard System



### CATCHER'S THROAT GUARD 4.5"

ARTICLE	COLOR	MSRP
WB5711501	Black	\$9.95

#### SIZES

ONE SIZE

**ENGINEERED** To securely mount to EvoShield catcher's helmets and facemasks

**LIGHTWEIGHT ABS PLASTIC**

## HOW TO MEASURE EVOSHIELD CATCHER'S GEAR

### PRO-SRZ HELMET

	Small	Medium	Large	S/M	L/XL
Hat Size	6½-7	7-7½	7½-8	6¾-7	7-7¾
Circumference IN	20½-22	22-23½	23½-25	19½-22	22-24½
Circumference CM	52-55.8	55.8-59.6	59.6-63.5	50.1-55.8	55.8-61.5

#### HOW TO MEASURE

Measure the circumference of your head above your ears in inches or centimeters. Refer to the chart above to determine the best size.

### PRO-SRZ CHEST PROTECTOR

Sport	Baseball	Baseball	Fastpitch	Fastpitch
Product Size	Adult 16"	Intermediate 15"	Adult 15"	Intermediate 13.5"
Chest Measurement	15" 6 Above	15" 6 Below	13.5" 6 Above	13.5" 6 Below

#### HOW TO MEASURE

Measure from the collarbone to the waist line in inches. If the player measure in between lengths, it is recommended to select the longer length.

### PRO-SRZ LEG GUARD

Sport	Baseball	Baseball	Fastpitch
Product Size	Adult	Intermediate	OSFM
Leg Measurement	15.5-17.5"	13.5-15.5"	13.5-15.5"

#### HOW TO MEASURE

In a seated position, with your foot at a 90-degree angle to the floor, measure the distance in inches from the center of your kneecap to the bend of your ankle.





# C1K™ CATCHER'S GEAR

3-PIECE CATCHER'S SET WITH NOCSAE® APPROVED CHEST PROTECTION

C1K™ Catcher's Gear is designed for durability and sturdiness, but built with MLB® Pro style and feel in mind. Whether you're an adult or intermediate player, the C1K™ Catcher's Gear set will protect you all season long.



ADULT

## C1K™ CATCHER'S GEAR KIT

STOCK NO.	SIZE	MSRP (ADULT)	MSRP (INTERMEDIATE)
WTA4603	Adult	\$339.95	\$299.95
WTA4604	Intermediate		

Kit Includes:  
Catcher's Helmet, Chest Protector and Leg Guards

**Helmet:**  
Glossy finish • Removable moisture-wicking chin pad • Adjustable straps for custom fit • SEI CERTIFIED: Product meets NOCSAE® Applicable Standard



Sizes: Adult [71/8-7½], Intermediate [63/8-71/8]

**Chest Protector:**  
High-density foam padding for ultimate comfort and protection • Removable shoulder caps for increased mobility • Over-the-shoulder adjustable harness • Precision, angled pad design to help block the ball straight down • SEI CERTIFIED: Product meets NOCSAE® Applicable Standard



Sizes: Adult [15"], Intermediate [13.5"]

**Leg Guards:**  
Inner knee pad protects knees, removable for washing • Overlapping thigh pieces for maximum protection • Lightweight premium grade ABS plastic • Adjustable metal buckles for easy on/off and snug fit

Sizes: Adult [15.5"], Intermediate [14"]

ADULT SIZE: Recommended for ages 15+  
INTERMEDIATE SIZE: Recommended for ages 12-15

### AVAILABLE IN COLORS



BL BLACK SC SCARLET NA NAVY RO ROYAL

## C1K™ CHEST PROTECTOR

STOCK NO.	SIZE	MSRP (ADULT)	MSRP (INTERMEDIATE)
WTA4605	Adult 15"	\$119.95	\$109.95
WTA4606	Intermediate 13.5"		

**Chest Protector:**  
High-density foam padding for ultimate comfort and protection • Removable shoulder caps for increased mobility • Over-the-shoulder adjustable harness • Precision, angled pad design to help block the ball straight down • SEI CERTIFIED: Product meets NOCSAE® Applicable Standard



### AVAILABLE IN COLORS



BL BLACK SC SCARLET NA NAVY RO ROYAL



ADULT



INTERMEDIATE



# NEW YOUTH CATCHER'S GEAR KITS

## NEW C200™ YOUTH CATCHER'S GEAR

Made from extra-tough, lightweight materials that keep you protected while easily moving with you. Designed for easy on and off between innings, the C200™ catcher's set will keep catchers of every skill level safe and in the game.

ARTICLE	SIZE	COLOR	MSRP
WB5711601	Youth (Age 7-12)	Black	\$229.95
WB5711602		Black/Orange	
WB5711603		Black/Scarlet	
WB5711604		Navy	
WB5711605		Navy/Scarlet	
WB5711606		Royal	
WB5711607		Scarlet	

Kit Includes:  
Catcher's Helmet, Chest Protector and Leg Guards

**Helmet:**  
Premium grade ABS shell with glossy finish • Moisture-wicking chin pad • SEI CERTIFIED: Product meets NOCSAE® applicable standard



Sizes: Youth [6 3/8-7 1/8]

**Chest Protector:**  
High-density foam padding • Over-the-shoulder harness • Precision pad design to help block the ball down • NOCSAE® PROTECTIVE CHEST GUARD Built-in/Removable pocket houses NOCSAE® Chest Guard Included • NOCSAE® protective chest guard MUST be worn with this catcher's chest protector for the chest protector to adhere to NOCSAE® standards and regulations



Sizes: Youth [12"]

## EVOSHIELD® NOCSAE PROTECTIVE CHEST GUARD

ARTICLE WB5708701

**SAS-TEC™ GUARD** extremely lightweight and durable protection. This chest guard is certified by SEI to meet the NOCSAE® standard for protection against Commotio Cordis. NOCSAE® chest guard MUST be worn with this catcher's chest protector for the chest protector to adhere to NOCSAE® standards and regulations.



**Leg Guards:**  
Lightweight premium grade ABS plastic • Anatomically inspired design • Adjustable metal buckles for easy on/off and snug fit

Sizes: Youth [13"]



### AVAILABLE IN COLORS



BL BL/OR BL/SC NA NA/SC RO SC

## NEW EZ GEAR™ 2 YOUTH CATCHER'S GEAR

Built with QuickChange™ technology for easy on-and-off between innings, the updated EZ Gear™ 2 kit features an improved ergonomic fit for catchers.

ARTICLE	SIZE	COLOR	MSRP
WB5720201	L/XL (Ages 7-12) S/M (Ages 5-7)	Black	\$159.95
WB5720204		Navy	
WB5720206		Royal	
WB5720207		Scarlet	

Kit Includes:  
Catcher's Helmet, Chest Protector and Leg Guards

**Helmet:**  
Premium grade ABS shell with glossy finish • Venting technology to maintain protection while keeping your head cool • Meets NOCSAE® protection standard.



Sizes: S/M [6-7] L/XL [7-7 7/8]

**Chest Protector:**  
One-time-adjustable QuickChange™ system – set it and forget it • Easy on/off hook and loop closure • Form fitting design • Removable shoulder caps • Multi-point adjustment system

Sizes: S/M [11"] L/XL [13"]

**Leg Guards:**  
One-time-adjustable QuickChange™ system – set it and forget it • Easy on/off hook and loop closure • Form fitting design

Sizes: S/M [10 1/2"] L/XL [12"]



### AVAILABLE IN COLORS



BLACK NAVY ROYAL SCARLET

# UMPIRE GEAR



The Wilson Pro Gold™ 2 Chest Protector boasts a modernized fit and customizable features to perfectly conform to your body. Available with two padding types — Air Management for maximum protection or Memory Foam for a low profile — the chest protector features a magnetic Fidlock® buckle for secure protection behind the plate. The improved Wilson leg guards include adjustable ankle plates with a hybrid padding system for custom protection.



### NEW PRO GOLD™ 2 CHEST PROTECTOR - MEMORY FOAM

ARTICLE	SIZE	COLOR	MSRP
WB5720301	S/M, M/L, L/XL	Black/Charcoal	\$249.95

Low profile memory foam padding for comfort fit • HINGED SHOULDER PLATES For maximum protection and mobility • FIDLOCK® BUCKLE Strong magnetic design with slide release allows for easy on/off • COMFORT NEOPRENE HARNESS With adjustable elastic straps for perfect fit • EXTRA SIDE PROTECTION Around the ribs for extra comfort and protection

SIZE: S-M [11"] M-L [12"] L-XL [13"]



### NEW PRO GOLD™ 2 CHEST PROTECTOR - AIR MANAGEMENT

ARTICLE	SIZE	COLOR	MSRP
WB5720401	S/M, M/L, L/XL	Black	\$229.95

Air management system, lightweight with maximum protection • HINGED SHOULDER PLATES For maximum protection and mobility • FIDLOCK® BUCKLE Strong magnetic design with slide release allows for easy on/off • COMFORT NEOPRENE HARNESS With adjustable elastic straps for perfect fit • EXTRA SIDE PROTECTION Around the ribs for extra comfort and protection

SIZE: S-M [11"] M-L [12"] L-XL [13"]



### NEW PRO GOLD™ 2 CHEST PROTECTOR HARNESS

ARTICLE	SIZE	COLOR	MSRP
WB5720601	OS	Black	\$29.99

ADJUSTABLE CHEST PROTECTOR HARNESS WITH FIDLOCK® BUCKLE CLOSURE • LONG, ADJUSTABLE ELASTIC STRAPS To better fit all body types • NEOPRENE COMFORT HARNESS With Wilson Gold "W" Strap

DIMENSIONS: Shoulder Straps (measured from base) [14"] Body Straps (measured from base [19"] Total Width [42"]



### NEW PRO GOLD™ 2 LEG GUARDS

ARTICLE	SIZE	COLOR	MSRP
WB5720501	S/M, M/L, L/XL	Black	\$149.95

HYBRID PADDING SYSTEM Air management foam with memory foam center channel • EXTENDED FOAM PADDING Around knee cap for 180 degree protection • ADJUSTABLE ANKLE PLATES For custom protection • REMOVABLE/ADJUSTABLE Hook and loop toe cap

DIMENSIONS: Shoulder Straps (measured from base) [14"] Body Straps (measured from base [19"] Total Width [42"]



## BUILD YOUR OWN FACEMASK

Select your preferred facemask pads, cage & harness to craft your facemask just how you want it. Pick out your facemask pads and choose from titanium, aluminum and steel cage options to complete your custom facemask.

CAGE & HARNESS	DYNA-LITE™		
ARTICLE	WB5720801	WB5720901	WB5720701
MATERIAL	TITANIUM	ALUMINUM	STEEL
COLOR	NATURAL	BLACK	BLACK
MSRP	\$220.95	\$99.95	\$39.95

FACEMASK PADS				
	ARTICLE	WB5721001	WB5721301	WB5721201
MATERIAL	FULL GRAIN LEATHER	PU/LEATHER	SYNTHETIC LEATHER	MEMORY FOAM
COLOR	TAN	BLACK/TAN	BLACK	BLACK
MSRP	\$59.95	\$49.95	\$39.95	\$39.95

UMPIRE HELMETS	PRO STOCK™		THROAT PROTECTOR REPLACEMENT MASK HARNESS	
STOCK NO.	WTA5800BL	WTA5801BL	WTA3901 BLA: 6" WTA3902 BLA: 4"	WTA3927
SIZE	7-7½	7-7½	Throat Protector	Three-Point Adjustable Umpire Facemask Replacement Harness
CAGE MATERIAL	TITANIUM	STEEL		
FRAMES	Matte Finish	Glossy Finish	• Durable ABS plastic throat protector • Header card and polybag packaging	• High-stretch elastic and durable webbing • Secure, quick adjusting buckles
PAD TYPE	Removable Moisture-Wicking Pads	Removable Moisture-Wicking Pads		
MSRP	\$329.95	\$159.95	\$9.95	\$14.95



Hinged shoulder plates



Extra side protection



WHILE SUPPLIES LAST

### PRO GOLD™ CHEST PROTECTOR

STOCK NO.	SIZE	COLOR	MSRP
WTA3210 BLA S-M	11"	Black	\$209.95
WTA3210 BLA M-L	12"		
WTA3210 BLA L-X	12¾"		

Hinged shoulder plates for a better fit • Fitted with extra side protection around the ribs for extra comfort and protection • Longer length than other umpire chest protectors • Removable pads for cleaning



Extra neck padding



Removable armor and washable lining



WHILE SUPPLIES LAST

### PRO PLATINUM™ CHEST PROTECTOR

STOCK NO.	SIZE	COLOR	MSRP
WTA3215 CHA1075	10¾"	Charcoal	\$199.95
WTA3215CHA12	12"		

Fitted with extra side protection and neck pad for extra comfort and protection • Increase sternum protection • Contoured shoulder plates • Removable pads for cleaning



### UMPIRE REPLACEMENT HARNESS

STOCK NO.	MSRP
WTA6796BL	\$19.95

Neoprene with Elastic Straps • Adjustable Harness with metal T-Clips • Compatible with all Wilson umpire chest protectors



Bridged Comfort System™



Expanded ankle plates



WHILE SUPPLIES LAST

### PRO GOLD™ LEG GUARDS

STOCK NO.	SIZE	COLOR	MSRP
WTA3409 WV16-17	16-17"	Black	\$139.95
WTA3409 WV18-19	18-19"		

Expanded adjustable ankle plates • Reinforced padding along shin • Removable padding for easy cleaning • Adjustable triple-kneecap design for precise fit and extra coverage



WHILE SUPPLIES LAST

### PRO PLATINUM™ LEG GUARDS

STOCK NO.	SIZE	COLOR	MSRP
WTA3417 CHA155	15½"	Charcoal	\$129.95
WTA3417GR	17"		
WTA3417 CHA185	18½"		

Flared adjustable ankle plates adjustable ankle plates • Reinforced padding along shin • Removable padding for easy cleaning • Adjustable double-kneecap design for precise fit • Removable toe cap



UMPIRE FACEMASKS	DYNA-LITE™				NEW VIEW™
	[577g]	[549g]	[757g]	[759g]	[688g]
STOCK NO.	WTA3009TI	WTA3009AL	WTA3017 BLA	WTA3009XBLA WV	WTA3077 BLST
CAGE MATERIAL	TITANIUM	ALUMINIUM	STEEL	STEEL	STEEL
PAD MATERIAL	Two Tone, Black PU and Tan Leather	Memory Foam Pads Wrapped in Moisture Wicking Fabric	Absorbent Synthetic Inner, PU Outer	Two Tone, Black PU and Tan Leather	Two Tone, Black PU and Tan Leather
MSRP	\$279.95	\$139.95	\$79.95	\$89.95	\$99.95

FACEMASK REPLACEMENT PARTS			
	[133g]	[151g]	[123g]
STOCK NO.	WTA3816BL	WTA3816TN	WTA3817BL
PRODUCT INFO	Outer PU, Inner Full Grain Tan Leather	Full Grain Leather	Memory Foam Pads Wrapped in Moisture Wicking Fabric
ADDITIONAL PRODUCT INFO	Non Wrap Around	Non Wrap Around	Non Wrap Around
MSRP	\$49.95	\$59.95	\$39.95

All facemask replacement parts are compatible with Wilson Dyna-Lite™ and Wilson New View™ umpire facemasks.

UMPIRE KIT	
STOCK NO.	WTA6754
INCLUDES	Includes umpire brush, ball strike counter and ball bag
MSRP	\$9.95



## COACH ACCESSORIES



### LINE-UP CARDS

STOCK NO.	MSRP
WTA6761	\$17.95

Boxed Line-up Cards (30 pack)



### SPIRAL SCOREBOOK

STOCK NO.	MSRP
WTA3753	\$9.95

New, easy to read format • Includes pitch counter • Enough pages to record 30 games

# PROTECTIVE GEAR



### SECTION BRANDS

EVOSHIELD

2022

PROTECTIVE GEAR



## PRO-SRZ™



### PRO-SRZ™ BATTER'S DOUBLE STRAP ELBOW GUARD

ARTICLE	SIZE	ARTICLE	SIZE	COLOR	MAP
WB5722901	Large	WB5724801	Small	X-SRZ Autism Speaks	\$84.95
WB5714801	Large	WB5714801	Small	X-SRZ USA20 Navy	
WB5706601	Large	WB5714601	Small	Black	\$74.95
WB5706602	Large	WB5714602	Small	White	
WB5706603	Large	WB5714604	Small	Royal	
WB5706604	Large	WB5714605	Small	Scarlet	
WB5706605	Large	WB5714603	Small	Navy	

ERGONOMIC DESIGN Engineered for a more personalized fit and maximum protection  
 GEL-TO-SHELL® TECHNOLOGY Begins soft and flexible, transforms to hard and protective in minutes  
 DISPERSION TECHNOLOGY Spreads the force across the surface of the shield, minimizing felt impact  
 SHIELD IS HAND WASHABLE Air dry  
 GUARD COVERAGE LARGE: [9.25" W x 9" H with double strap] SMALL: [9.25" W x 7" H with double strap]



### PRO-SRZ™ BATTER'S ELBOW GUARD

STOCK NO. / ARTICLE	SIZE	COLOR	MAP
WB5723001	Large	X-SRZ Autism Speaks	\$64.95
WB5724701	Small	X-SRZ Autism Speaks	
WB5714701	Large	X-SRZ USA20 Navy	
WB5714701	Small	X-SRZ USA20 Navy	
WTV6200	Large	BL, WH, RO, SC, NA	\$54.95
WTV6201	Small	BL, WH, RO, SC, NA	

ERGONOMIC DESIGN Engineered for a more personalized fit and maximum protection  
 GEL-TO-SHELL® TECHNOLOGY Begins soft and flexible, transforms to hard and protective in minutes  
 DISPERSION TECHNOLOGY Spreads the force across the surface of the shield, minimizing felt impact  
 SHIELD IS HAND WASHABLE Air dry  
 GUARD COVERAGE LARGE: [9.25" W x 6.5" H with single strap] SMALL: [7.5" W x 5.5" H with single strap]



### PRO-SRZ™ BATTER'S LEG GUARD

STOCK NO. / ARTICLE	SIZE/ HITTER	COLOR	MAP
WB5714901	ADULT LHH, ADULT RHH	X-SRZ USA20 Navy	\$84.95
WTV1200	ADULT LHH, ADULT RHH	BL, WH, RO, SC, NA	\$69.95

ERGONOMIC DESIGN Engineered for a more personalized fit and maximum protection  
 GEL-TO-SHELL® TECHNOLOGY Begins soft and flexible, transforms to hard and protective in minutes  
 DISPERSION TECHNOLOGY Spreads the force across the surface of the shield, minimizing felt impact  
 SHIELD IS HAND WASHABLE Air dry  
 GUARD COVERAGE 8.5" W x 12" H, extending to protect inner ankle  
 BATTER'S STANCE Choose RHH for right-handed hitters (worn on LEFT leg) and LHH for left-handed hitters (worn on RIGHT leg)



## PRO-SRZ™



### PRO-SRZ™ YOUTH BATTER'S LEG GUARD

STOCK NO.	SIZE	COLORS	MAP
WTV1201	Youth OSFM	BL, WH	\$64.95

ERGONOMIC DESIGN Engineered for a more personalized fit and maximum protection  
 GEL-TO-SHELL® TECHNOLOGY Begins soft and flexible, transforms to hard and protective in minutes  
 DISPERSION TECHNOLOGY Spreads the force across the surface of the shield, minimizing felt impact  
 SHIELD IS HAND WASHABLE Air dry  
 GUARD COVERAGE 7.5" W x 9.5" H, extending to protect both ankles  
 BATTER'S STANCE For right-handed, left-handed and switch hitters



### PRO-SRZ™ PROTECTIVE WRIST GUARD

STOCK NO.	SIZE	COLORS	MAP
WTV5200	S-XL	BL, WH, NA, RO, SC	\$29.95

SOFT NEOPRENE Compression sleeve with molded pull tab and interior pocket for Gel-to-Shell® Wrist Shield (included)  
 GEL-TO-SHELL® TECHNOLOGY Begins soft and flexible, transforms to hard and protective in minutes  
 DISPERSION TECHNOLOGY Spreads the force across the surface of the shield, minimizing felt impact  
 SLEEVE AND SHIELD ARE HAND WASHABLE air dry  
 SIZING Measure your wrist circumference to determine the best fit  
 S: [5"-6"], M: [6"-7"], L: [7"-8"], XL: [8"-9"]



### PRO-SRZ™ GUARD STRAP

STOCK NO.	SIZE	COLOR	MSRP
WTV5TRP	OS	NA, RO, SC, WH, OR, PR, GR, MA, GY, BL, YE	\$19.95

CUSTOMIZE YOUR LOOK With a pop of color, compatible with all GEL-TO-SHELL® elbow and leg guards  
 2 INCH ELASTIC STRAP Adjustable for desired guard compression  
 STRAP DIMENSIONS 12.25" L x 2" W



## HOW TO MEASURE EVOSHIELD ELBOW & LEG GUARDS

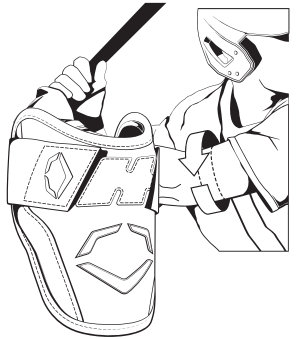

### ELBOW GUARD

PRODUCT	HEIGHT	ARM CIRCUMFERENCE
Large Pro-SRZ Elbow Guard	6.5"	> 10"
Small Pro-SRZ Elbow Guard	5.5"	< 10"
Large Pro-SRZ Double Strap Elbow Guard	9"	> 10"
Small Pro-SRZ Double Strap Elbow Guard	7"	< 10"

HOW TO MEASURE  
 Measure your arm circumference slightly above the elbow to determine best fit

### LEG GUARD

PRODUCT	HEIGHT
Adult Pro-SRZ Leg Guard	12"
Youth Pro-SRZ Leg Guard	9.5"

HOW TO MEASURE  
 Measurements are from top of inside leg to bottom of ankle protection

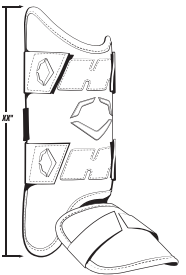



## SRZ-1™



WHILE SUPPLIES LAST



### SRZ-1™ BATTER'S ELBOW GUARD

STOCK NO.	SIZE	COLORS	MSRP
WTV6112	Large	WH, SC, RO, BL, NA, OR, GR, PR, MA, YE, GY	\$44.95
WTV6113	Small	WH, SC, RO, BL, NA	

GEL-TO-SHELL® TECHNOLOGY Begins soft and flexible, transforms to hard and protective in minutes  
 DISPERSION TECHNOLOGY Spreads the force across the surface of the shield, minimizing felt impact  
 CUSTOM-MOLDING SHIELD Molds to user's body shape, ensuring a perfect fit, custom molds to fit left or right-handed hitters

SHIELD IS HAND WASHABLE Air dry

GUARD COVERAGE LARGE: [9" W x 6" H] SMALL: [8" W x 5" H]



### SRZ-1™ YOUTH BATTER'S ELBOW GUARD

STOCK NO.	SIZE	COLORS	MAP
WTV6114	Youth	BL	\$29.95

GEL-TO-SHELL® TECHNOLOGY Begins soft and flexible, transforms to hard and protective in minutes  
 DISPERSION TECHNOLOGY Spreads the force across the surface of the shield, minimizing felt impact  
 CUSTOM-MOLDING SHIELD Molds to user's body shape, ensuring a perfect fit, custom molds to fit left or right-handed hitters

SHIELD IS HAND WASHABLE Air dry

GUARD COVERAGE YOUTH: [8" W x 5" H]



WHILE SUPPLIES LAST



### SRZ-1™ BATTER'S LEG GUARD

STOCK NO.	SIZE	COLORS	MSRP
WTV1112	Adult	WH, SC, RO, PR, NA, OR, GR, GY, MA, YE, BL	\$59.95
WTV1114	Youth	BL	\$54.95

GEL-TO-SHELL® TECHNOLOGY Begins soft and flexible, transforms to hard and protective in minutes  
 DISPERSION TECHNOLOGY Spreads the force across the surface of the shield, minimizing felt impact  
 CUSTOM-MOLDING SHIELD Molds to user's body shape, ensuring a perfect fit, reversible design  
 custom molds to fit left or right-handed hitters

SHIELD IS HAND WASHABLE Air dry

GUARD COVERAGE ADULT: [6.5" W x 10.5" H] YOUTH: [5" W x 8.75" H]



### NOCSAE® PROTECTIVE CHEST GUARD & SHIRT

STOCK NO.	SIZE	COLORS	MAP
WTV3200	Adult: S-L	BL	\$89.95
WTV3200	Youth: YS-YL	BL	

SLEEVELESS CHEST GUARD SHIRT With built-in pocket for SAS-TEC protective insert, shirt is machine washable

TWO PIECE COLLAR AND SIDE MESH PANELS For comfort and breathability

FABRIC 85% Nylon, 15% Spandex

SEI CERTIFIED Product meets NOCSAE® Applicable Standard



### NOCSAE® PROTECTIVE CHEST GUARD

ARTICLE WB5708701

SAS-TEC™ GUARD extremely lightweight and durable protection  
 This chest guard is certified by SEI to meet the NOCSAE® standard for protection against Commotio Cordis. NOCSAE® chest guard MUST be worn with this shirt for the shirt to adhere to NOCSAE® standards and regulations.



### MEN'S SLEEVELESS CHEST GUARD

STOCK NO.	SIZE	COLORS	MAP
WTV3100	Mens: S-L	CH	\$59.95
WTV3100	Boys: YS-YL	CH	

GEL-TO-SHELL® TECHNOLOGY Begins soft and flexible, transforms to hard and protective in minutes  
 DISPERSION TECHNOLOGY Spreads the force across the surface of the shield, minimizing felt impact  
 CUSTOM-MOLDING SHIELD Molds to user's body shape, ensuring a perfect fit

SWEAT-WICKING PERFORMANCE SHIRT Designed for increased comfort for the male athlete, machine washable

SHIELD IS HAND WASHABLE Air dry



### WOMEN'S RACERBACK CHEST GUARD

STOCK NO.	SIZE	COLORS	MAP
WTV1144103	Womens: S-L	GR	\$59.95
WTV1144103	Girls: YS-YL	GR	

GEL-TO-SHELL® TECHNOLOGY Begins soft and flexible, transforms to hard and protective in minutes  
 DISPERSION TECHNOLOGY Spreads the force across the surface of the shield, minimizing felt impact  
 CUSTOM-MOLDING SHIELD Molds to user's body shape, ensuring a perfect fit

SWEAT-WICKING RACERBACK SHIRT Designed for increased comfort and support for the female athlete. Machine washable

SHIELD IS HAND WASHABLE Air dry





### GEL-TO-SHELL® HAND GUARD

STOCK NO.	HITTER	COLORS	MSRP
WTV4012	RHH, LHH	BL	\$29.95

GEL-TO-SHELL® TECHNOLOGY Begins soft and flexible, transforms to hard and protective in minutes  
 DISPERSION TECHNOLOGY Spreads the force across the surface of the shield, minimizing felt impact  
 CUSTOM-MOLDING SHIELD Molds to user's body shape, ensuring a perfect fit, custom molds over batting glove

SHIELD IS HAND WASHABLE Air dry  
 GUARD COVERAGE [5"W x 3.5"H]



### CATCHER'S THUMB GUARD

STOCK NO.	SIZE	COLORS	MAP
WTV4000BL	S, L	BL	\$24.95

GEL-TO-SHELL® TECHNOLOGY Begins soft and flexible, transforms to hard and protective in minutes  
 DISPERSION TECHNOLOGY Spreads the force across the surface of the shield, minimizing felt impact  
 CUSTOM-MOLDING SHIELD Molds to user's body shape, ensuring a perfect fit, molds to fit left or right thumb, worn under glove

SHIELD IS HAND WASHABLE Air dry  
 GUARD COVERAGE LARGE: [4.5" x 4.5"] SMALL: [4.5"x3.25"]



### SLIDING MITT

STOCK NO.	HAND	COLORS	MSRP
WTV4054	RT (Right), LT (Left)	BL, NA, RO, SC	\$49.95

PROTECTIVE SHIELDS Cover the top and underside of the hand to protect fingers when sliding  
 ELASTIC COMPRESSION STRAP Secures and supports wrist, adjustable for quick on and off  
 THUMB HOLE for the ability to keep your thumb out, or tuck it in  
 CHOOSE LH FOR LEFT HAND AND RH FOR RIGHT HAND



### PROTECTIVE SLIDING WRIST GUARD

STOCK NO.	HAND	COLORS	MSRP
WTV2044154	Left Hand: S/M, L/XL	BL	\$44.95
WTV2044155	Right Hand: S/M, L/XL	BL	

WRIST SUPPORT For top (dorsal splint) and bottom (palmar splint) of wrist  
 ELASTIC COMPRESSION STRAP Secures and supports wrist, adjustable for quick on and off  
 HAND WASH In cold water, air dry  
 SIZING Measure your wrist circumference to determine the best fit. S/M [5"-7"], L/XL [7"+]



WRIST GUARD SHOWN LACED TO CATCHER'S MITT

### CATCHER'S WRIST GUARD

ARTICLE	SIZE	COLORS	MAP
WB5714001	OS	BL	\$69.95

GEL-TO-SHELL® TECHNOLOGY Begins soft and flexible, transforms to hard and protective in minute  
 DISPERSION TECHNOLOGY Spreads the force across the surface of the shield, minimizing felt impact

CUSTOM-MOLDING SHIELD Molds to user's body shape, ensuring a perfect fit, laces to catcher's mitt and molds to wrist

SHIELD IS HAND WASHABLE Air dry  
 GUARD COVERAGE [5"W x 4"H]

LACE INCLUDED 18" Black Leather Lace



### PLAYCALL COMPRESSION WRIST SLEEVE

STOCK NO.	SIZE	COLORS	MSRP
WTV5000BLOSFM	OSFM	BL	\$19.95

VIEWING WINDOW Clear plastic pocket for easy access to plays  
 NEOPRENE CONSTRUCTION Supports wrist with compression  
 NO-SLIP FIT To prevent having to readjust during game play  
 SLEEVE IS HAND WASHABLE Air dry  
 COVERAGE Length 5"



# BATTING HELMETS

SECTION BRANDS

EVOSHIELD

2022



## XVT™ LUXE FITTED BATTING HELMET

STOCK NO.	SIZE	MSRP
WTV7210	XS-2X	\$54.95
WTV7230 w/ Softball Mask	XS-2X	\$74.95

DUAL DENSITY PADDING Fully wrapped padding, fitted to your head size for a custom fit feel  
 PREMIUM HIGH GLOSS FINISH  
 STRATEGICALLY ENGINEERED Top plate venting system  
 SEI CERTIFIED Product meets NOCSAE® Applicable Standard  
 SIZES XS [6 5/8 - 6 3/4], S [6 7/8 - 7], M [7 1/8 - 7 1/4], L [7 3/8 - 7 1/2], XL [7 5/8 - 7 3/4], 2X [7 7/8 - 8]



## XVT™ BATTING HELMET

STOCK NO.	SIZE	MSRP
WTV7110 (Glossy)	YH, INT, S/M, L/XL	\$39.95
WTV7130 w/ Softball Facemask (Glossy)	YH, INT, S/M, L/XL	\$49.95
WTV7115 (Matte)	YH, INT, S/M, L/XL	\$39.95
WTV7135 w/ Softball Mask (Matte)	YH, INT, S/M, L/XL	\$49.95

SLEEK COMPRESSION MOLDED FOAM PADDING With fully wrapped ear pads  
 AVAILABLE IN TWO PREMIUM FINISHES High Gloss and Matte  
 STRATEGICALLY ENGINEERED Top plate venting system  
 SEI CERTIFIED Product meets NOCSAE® Applicable Standard  
 SIZES YH [6 1/2-7], INT [6 3/4-7 1/4], S/M [7-7 1/2], L/XL [7 1/2-8]





WHILE SUPPLIES LAST



### XVT™ SCION BATTING HELMET

STOCK NO.	SIZE	MSRP
WTV7010	YSM, YLX, S/M, L/XL	\$29.95
WTV7030 w/ Softball Mask	YSM, YLX, S/M, L/XL	\$39.95

SLEEK COMPRESSION MOLDED FOAM PADDING With comfort foam ear pads  
 SEMI GLOSS FINISH  
 SEI CERTIFIED Product meets NOCSAE® Applicable Standard  
 SIZES YSM [6-6 1/2], YLX [6 1/2-7], S/M [7-7 1/2], L/XL [7 1/2-8]



### XVT™ BATTING HELMET FACE SHIELD

STOCK NO.	HITTER	MSRP
WTV7300 (Glossy)	LHH, RHH	\$19.95
WTV7305 (Matte)	LHH, RHH	

ENGINEERED TO SECURELY MOUNT TO XVT™ BATTING HELMET Easy installation needs only two total screws (hardware included)  
 SUPERIOR COMFORT AND SIGHTLINES Lightweight ABS plastic with padded inner surface, tilt adjustment to maximize sightline  
 PROTECTS SIDE OF FACE EXPOSED TO PITCHER Choose right hand hitter (RHH) for right-handed hitters or left hand hitter (LHH) for left-handed hitters  
 AVAILABLE IN TWO PREMIUM FINISHES High Gloss and Matte  
 DOES NOT AFFECT The SEI NOCSAE® certification of the EvoShield® XVT™ Batting Helmets when properly installed



### XVT™ BATTING HELMET FACEMASK

STOCK NO.	SIZE	MSRP
WTV7330 Softball [For use with 11 inch softballs or larger]	S, L	\$14.95

GREAT SIGHT LINES Design optimized for increased visibility  
 ADJUSTABLE CHINSTRAP Included  
 EASY INSTALL Only four total screws (hardware included)  
 SMALL MASK FITS XVT™ Batting helmet sizes [YSM, YLX, YH, INT and S/M]  
 LARGE MASK FITS XVT™ Batting helmet sizes [L, XL, 2X, and L/XL]



### BATTING HELMET CHIN STRAP

STOCK NO.	SIZE	MSRP
WTV7200BLOSFM	OSFM	\$3.95

ENGINEERED TO BETTER SECURE HELMET for uninterrupted performance  
 FULLY ADJUSTABLE For custom fit and comfort  
 COMPATIBLE With all EvoShield® batting helmets



2022

SECTION BRANDS

EVOSHIELD  
LOUISVILLE SLUGGER

# BATTING GLOVES



NEW YOUTH SIZES

TEAM WHITE 05

### PRO-SRZ™ BATTING GLOVES

ARTICLE (ADULT)	ARTICLE (YOUTH)	COLOR	MSRP
WB5711801	WB5711901	Black	\$49.95
WB5711802	WB5711902	Navy	
WB5711803	WB5711903	Royal	
WB5711804	WB5711904	Scarlet	
WB5711805	WB5711905	Team White	
WB5711806	WB5711906	USA	

SIZES ADULT: S-2X // YOUTH: S-L

PREMIUM EMBOSSED SHEEPSKIN LEATHER PALM For strong grip and superior feel  
LIGHTWEIGHT PERFORMANCE KNIT BACKHAND MATERIAL For maximum flexibility  
VENTED HOLES For breath-ability and enhanced comfort  
MOLDED NEOPRENE CUFF For precise comfort fit



### NEW KHAOS BATTING GLOVES



SCARLET 04

ARTICLE (ADULT)	ARTICLE (YOUTH)	COLOR	MSRP
WB5722001	WB5722101	Black	\$44.95
WB5722002	WB5722102	Navy	
WB5722003	WB5722103	Royal	
WB5722004	WB5722104	Scarlet	
WB5722005	WB5722105	Team White	

SIZES ADULT: S-2X // YOUTH: S-L

LIGHTWEIGHT SUEDE BACKHAND  
STRATEGICALLY PLACED PERFORMANCE MESH For breathability and enhanced comfort  
SHEEPSKIN LEATHER PALM allows for increased grip  
LYCRA GUSSETS For flexibility  
MOLDED NEOPRENE CUFF Makes adjustments quick and easy



### STANDOUT BATTING GLOVES



NEW COLORS

SCARLET 08

ARTICLE (ADULT)	ARTICLE (YOUTH)	COLOR	MSRP
WB5712801	WB5712901	Black	\$39.95
WB5712802	WB5712902	Dark Green	
WB5712803	WB5712903	Maroon	
WB5712804	WB5712904	Navy	
WB5712805	WB5712905	Orange	
WB5712806	WB5712906	Purple	
WB5712807	WB5712907	Royal	
WB5712808	WB5712908	Scarlet	
WB5712809	WB5712909	Team White	
WB5712810	WB5712910	USA	

SIZES ADULT: S-2X // YOUTH: S-L

BREATHABLE 4 WAY STRETCH MESH BACKHAND For maximum breathability  
SHEEPSKIN PALM Allows for enhanced comfort  
LYCRA GUSSETS For flexibility  
NEOPRENE CUFF For precise comfort fit  
TECH6 INNER GRIP LINER Minimizes movement between your hand and the glove





WH/RO  
16

### NEW STANDOUT BATTING GLOVES

ARTICLE (ADULT)	ARTICLE (YOUTH)	COLOR	MSRP
WB5712811	WB5712911	White/Dark Green	\$39.95
WB5712812	WB5712912	White/Maroon	
WB5712813	WB5712913	White/Navy	
WB5712814	WB5712914	White/Orange	
WB5712815	WB5712915	White/Purple	
WB5712816	WB5712916	White/Royal	
WB5712817	WB5712917	White/Scarlet	

SIZES ADULT: S-2X // YOUTH: S-L

BREATHABLE 4 WAY STRETCH MESH BACKHAND For maximum breathability  
 SHEEPSKIN PALM Allows for enhanced comfort  
 LYCRA GUSSETS For flexibility  
 NEOPRENE CUFF For precise comfort fit  
 TECH6 INNER GRIP LINER Minimizes movement between your hand and the glove



WH/DG 11 WH/MA 12 WH/NA 13 WH/OR 14 WH/PR 15 WH/RO 16 WH/SC 17



RO

### NEW DAZE BATTING GLOVES

ARTICLE (ADULT)	ARTICLE (YOUTH)	COLOR	MSRP
WB5722201	WB5722301	Black	\$34.95
WB5722202	WB5722302	Navy	
WB5722203	WB5722303	Royal	
WB5722204	WB5722304	Scarlet	
WB5722205	WB5722305	Team White	

SIZES ADULT: S-2X // YOUTH: S-L

SUBLIMATED TIE DYE MESH BACKHAND  
 SYNTHETIC PALM For more comfort at the plate  
 LYCRA GUSSETS For flexibility  
 NEOPRENE CUFF Makes in-game adjustments easier  
 IRIDESCENT APPLIED LOGO



BLACK 01 NAVY 02 ROYAL 03 SCARLET 04 TEAM WHITE 05



USA  
10

NEW  
COLORS

### SRZ-1™ BATTING GLOVES

ARTICLE (ADULT)	ARTICLE (YOUTH)	COLOR	MSRP
WB5712001	WB5712101	Black	\$29.95
WB5712002	WB5712102	Dark Green	
WB5712003	WB5712103	Maroon	
WB5712004	WB5712104	Navy	
WB5712005	WB5712105	Orange	
WB5712006	WB5712106	Purple	
WB5712007	WB5712107	Royal	
WB5712008	WB5712108	Scarlet	
WB5712009	WB5712109	Team White	
WB5712010	WB5712110	USA	
WB5712011	WB5712111	Victory Blue	

SIZES ADULT: S-2X // YOUTH: S-L

ONE-PIECE EMBOSSED Synthetic palm  
 BREATHABLE 4 WAY STRETCH MESH BACKHAND For maximum breathability  
 LYCRA GUSSETS For flexibility  
 NEOPRENE CUFF For precise comfort fit



BLACK 01 DARK GREEN 02 MAROON 03 NAVY 04 ORANGE 05 PURPLE 06 ROYAL 07 SCARLET 08 TEAM WHITE 09 USA 10 VICTORY BLUE 11



BL

### GENUINE™ BATTING GLOVES

ARTICLE (ADULT)	ARTICLE (YOUTH)	COLOR	MSRP
WTL6104BL	WTL6304BL	Black	\$19.95
WTL6104NA	WTL6304NA	Navy	
WTL6104RO	WTL6304RO	Royal	
WTL6104PK	WTL6304PK	Pink	
WTL6104PR	WTL6304PR	Purple	
WTL6104SC	WTL6304SC	Scarlet	
WTL6104WH	WTL6304WH	White	

SIZES ADULT: S-2X // YOUTH: S-L

- **FUNCTION** Embossed synthetic palm and thumb for no-slip grip
- **FLEXIBILITY** Stretch mesh on backhand for better mobility, flexibility and breathability
- **FIT** Neoprene wrist strap for comfort fit and support



BL NA RO PK PR SC WH



SECTION BRANDS

WILSON  
DEMARINI

2022

BASEBALL

# BASEBALLS & SOFTBALLS

HIGH SCHOOL STATE ADOPTIONS

AHSAA	ALABAMA
AIA	ARIZONA
CAA	ARIZONA
AAA	ARKANSAS
CIF	CENTRAL COAST CALIFORNIA
CIF	CENTRAL CALIFORNIA
CIF	SAN JOAQUIN CALIFORNIA
CHSAA	COLORADO
DIAA	DELAWARE
DCSAA	DISTRICT OF COLUMBIA
FHSA	FLORIDA
FICAA	FLORIDA
GHSA	GEORGIA
GISA	GEORGIA
GICAA	GEORGIA
IHSA	ILLINOIS
IHSAA	INDIANA
MPSSA	MARYLAND
MHSAA	MICHIGAN
MSHSL	MINNESOTA
MHSAA	MISSISSIPPI
MAIS	MISSISSIPPI
NIAA	NEVADA
NHIAA	NEW HAMPSHIRE
NJSIAA	NEW JERSEY
NMAA	NEW MEXICO
NCHSAA	NORTH CAROLINA
NCISAA	NORTH CAROLINA
OSSAA	OKLAHOMA
OSAA	OREGON
SCHSL	SOUTH CAROLINA
TSSAA	TENNESSEE
TAPPS	TEXAS
TCAL	TEXAS
UHSAA	UTAH
VHSL	VIRGINIA
VISAA	VIRGINIA

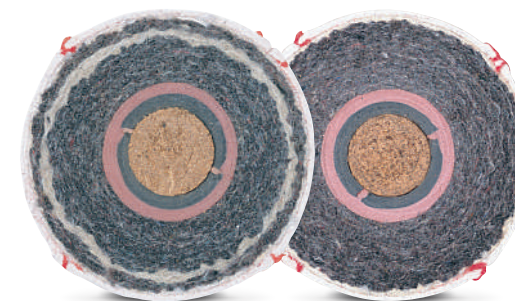
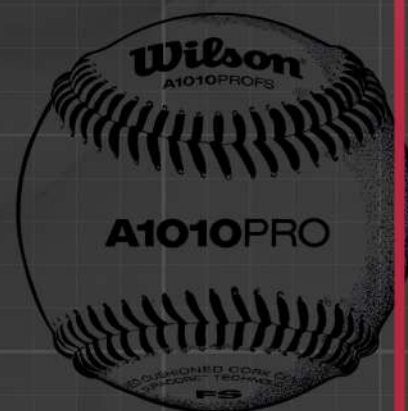

DURA-CORE TECHNOLOGY™

RED CUSHIONED CORK

## CORES BASEBALL

**DURA-CORE TECHNOLOGY™:**  
Added to Red Cushioned Cork to help the ball retain hardness. Formed to withstand impact and give you the game-changing performance you need.

**RED CUSHIONED CORK:**  
Gives a Wilson® baseball the ability to keep its shape and firmness, allowing for better pop off the bat.



SUPER SEAM TECHNOLOGY™



FLAT SEAMS

## SEAMS BASEBALL

**SUPER SEAM TECHNOLOGY™:**  
With seams 20% higher than raised seam baseballs, pitchers experience superior control on the mound. Fielders can locate the ball quickly in their gloves and throw with more accuracy.

**FLAT SEAMS:**  
The most aerodynamic Wilson® baseball, these balls fly further, giving both pitchers and hitters a true feel of the ball.



### PRO SERIES: COLLEGIATE AND HIGH SCHOOL ELITE GAME PLAY

A1001  
STOCK NO.  
WTA1001BFS

COVER  
Grade A Full Grain Leather  
SEAM WINDS  
Flat Premium Gray & White Wool  
CENTER  
Red Cushioned Cork with Dura-Core Technology™



A1010 PRO  
STOCK NO.  
WTA1010BPROFS\*  
WTA1010BPROSST

COVER  
Grade A Full Grain Leather  
SEAM WINDS  
SST Premium Gray & White Wool  
Flat Premium Gray & White Wool  
CENTER  
Red Cushioned Cork with Dura-Core Technology™



\*WILL NOT HAVE NFHS/NOCSAE STAMP



A1010 HS1  
STOCK NO.  
WTA1010BHS1SST

COVER  
Grade B Full Grain Leather  
SEAM WINDS  
SST Gray Wool  
CENTER  
Red Cushioned Cork with Dura-Core Technology™



AVAILABLE IN RETAIL PACK  
STOCK NO.  
WTA1010THS1SST

A110 HS1  
AMERICAN LEGION  
STOCK NO.  
WTA1010BHS1AL1

COVER  
Grade B Full Grain Leather  
SEAM WINDS  
SST Gray Wool  
CENTER  
Red Cushioned Cork with Dura-Core Technology™



A1015  
STOCK NO.  
WTA1015BSST

COVER  
Grade C Full Grain Leather  
SEAM WINDS  
SST Gray Wool  
CENTER  
Red Cushioned Cork with Dura-Core Technology™





## CHAMPION SERIES: GAME PLAY AND PRACTICE

A1020

STOCK NO.  
WTA1020BSST

COVER  
Grade C  
Full Grain Leather

SEAM WINDS  
SST Gray Wool

CENTER  
Red Cushioned Cork with  
Dura-Core Technology™

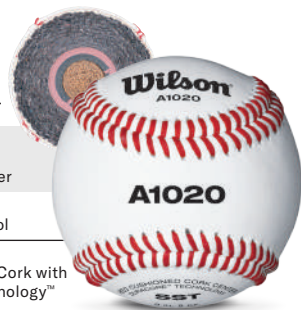

A1030

STOCK NO.  
WTA1030B  
WTA1030BFS

COVER  
Grade C/D  
Full Grain Leather

SEAM WINDS  
SST Gray Wool  
Flat Gray Wool

CENTER  
Red Cushioned Cork

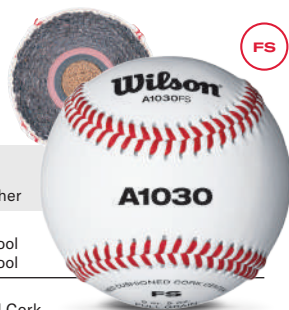

A1035

STOCK NO.  
WTA1035B0

COVER  
Grade C/D  
Full Grain Leather

SEAM WINDS  
SST Gray Wool

CENTER  
Black Cork & Rubber



## TOURNAMENT SERIES: YOUTH LEAGUE ELITE GAME PLAY

SST SERIES  
AVAILABLE WITH  
THE FOLLOWING  
STAMPS:

COVER  
Grade C/D Full Grain Leather

SEAM WINDS  
SST Gray Wool

CENTER  
Red Cushioned Cork



## LEAGUE SERIES: YOUTH LEAGUE GAME PLAY

1 SERIES  
AVAILABLE WITH  
THE FOLLOWING  
STAMPS:

COVER  
Grade C/D Full Grain Leather

SEAM WINDS  
SST Gray Wool

CENTER  
Black Cork & Rubber



STOCK NO.  
WTA1066BDBM1 WTA1082BBR1 WTA1078BCR1 WTA1035BUSSSA



## PRACTICE BALLS

A1060

STOCK NO.  
WTA1060B

COVER  
White Split Leather

SEAM WINDS  
SST Gray Wool

CENTER  
Cork & Rubber



A1274

COVER  
White Split Leather

SEAM  
SST

CENTER  
Cork & Rubber

AVAILABLE IN RETAIL PACK ONLY

STOCK NO.  
WTA1274T WTA1274WSHRINK



## RETAIL SERIES

A1250

COVER  
Synthetic Leather

SEAM  
Flat

HITS  
Good for up to 15 hits

AVAILABLE IN RETAIL PACK ONLY

STOCK NO.  
WTA1250TO



A1150

COVER  
Dura-Lon® Synthetic Leather

SEAM  
Flat

HITS  
This ball is NON-HITTABLE

AVAILABLE IN RETAIL PACK ONLY

STOCK NO.  
WTA1150T WTA1150WSHRINK



## SOFT COMPRESSION BASEBALLS

A sponge center creates a soft compression ball that makes youth play and indoor training more successful.

LEVEL 1: 93% softer than traditional baseballs

LEVEL 5: 85% softer than traditional baseballs

A1217

STOCK NO.  
WTA1217B

COVER  
Composite Leather

SEAM LEVEL  
Flat 1

CENTER  
Sponge Center

AVAILABLE IN RETAIL PACK

STOCK NO.  
WTA1217T



A1228

STOCK NO.  
WTA1228B

COVER  
Composite Leather

SEAM LEVEL  
Flat 5

CENTER  
Sponge Center

AVAILABLE IN RETAIL PACK

STOCK NO.  
WTA1228T



## PRACTICE BUCKETS

BALL BUCKET WITH LID

STOCK NO.  
WTA3948

Holds 4 Dozen Baseballs



A1098 X-OUT  
BUCKET COMBO

STOCK NO.  
WTA1098 X-OUT

3 Dozen A1010S Balls;  
1 A3948 Ball Bucket

A1098 1030  
BUCKET COMBO

STOCK NO.  
WTA1098 1030

3 Dozen A1030 Balls;  
1 A3948 Ball Bucket



# CUSTOM LOGOS & SEAMS

The options for game and practice balls are endless with Wilson® custom baseballs and softballs. Hit up your local team dealer or Territory Manager with your logo and seam color choices to place an order.

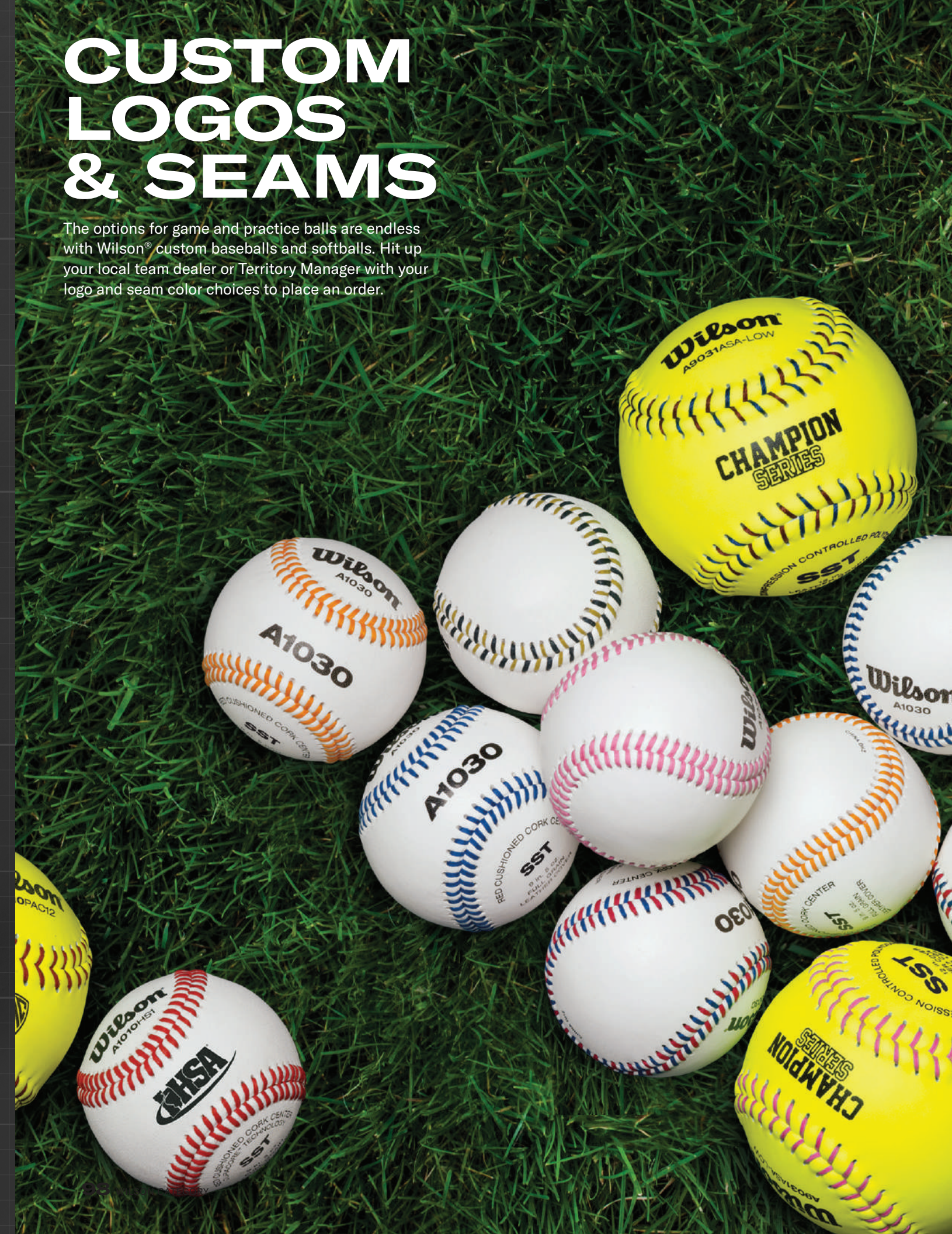

## CORES SOFTBALL

COMPRESSION CONTROLLED POLYCORE      COMPRESSION CONTROLLED CORK

**COMPRESSION CONTROLLED POLYCORE:**  
The most consistent playing softball in the world. Polycore softballs don't break down as quickly, giving you unmatched durability for performance.

**COMPRESSION CONTROLLED CORK:**  
Exclusive to Wilson®, this softball offers the traditional feel you need at the price you want.

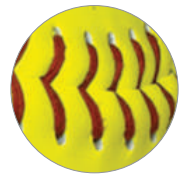

SUPER SEAM TECHNOLOGY™

## SEAMS SOFTBALL

**SUPER SEAM TECHNOLOGY™:**  
With seams 20% higher than raised seam baseballs, pitchers experience superior control on the mound. Fielders can locate the ball quickly in their gloves and throw with more accuracy.

### COLLEGIATE AND HIGH SCHOOL

#### A9010

STOCK NO.  
WTA9010BSST: 12"

COVER				
Leather				
Freq. Matched Optic Yellow™				
SEAM	STITCH	COR.	COMP.	
Flat	Red	.47	400 lbs.	
CENTER				
Compression Controlled Polycore				



#### A9011

STOCK NO.  
WTA9011BSST: 12"

COVER				
Leather				
Freq. Matched Optic Yellow™				
SEAM	STITCH	COR.	COMP.	
SST	Red	.47	375 lbs.	
CENTER				
Compression Controlled Polycore				



#### A9016

STOCK NO.  
WTA9016BSST: 12"

COVER				
Leather				
Freq. Matched Optic Yellow™				
SEAM	STITCH	COR.	COMP.	
SST	Red	.47	375 lbs.	
CENTER				
Compression Controlled Cork				



#### A9244

STOCK NO.  
WTA9244BNFHSYR: 11"

COVER				
Leather				
Freq. Matched Optic Yellow™				
SEAM	STITCH	COR.	COMP.	
Flat	Red	.44	375 lbs.	
CENTER				
Compression Controlled Polycore				





## USA

### USA SOFTBALL®

STOCK NO.  
WTA9031BASA-LOW: 12"  
WTA9231BASA-LOW: 11"

COVER  
Leather  
Freq. Matched Optic Yellow™

SEAM STITCH COR COMP.  
SST Red .47 375 lbs.

CENTER  
Compression Controlled Polycore

STOCK NO.  
WTA9131BASA-LOW: 12"  
WTA9331BASA-LOW: 11"

COVER  
Synthetic Leather  
Freq. Matched Optic Yellow™

SEAM STITCH COR COMP.  
SST Red .47 375 lbs.



AVAILABLE IN RETAIL PACK

STOCK NO.  
WTA9031TASA-LOW

### USA SOFTBALL®

STOCK NO.  
WTA9060BASA-LOW: 12"  
WTA9260BASA-LOW: 11"

COVER  
Leather  
Freq. Matched Optic Yellow™

SEAM STITCH COR COMP.  
SST Red .47 375 lbs.

CENTER  
Compression Controlled Cork

STOCK NO.  
WTA9106BASA-LOW: 12"  
WTA9306BASA-LOW: 11"

COVER  
Synthetic Leather  
Freq. Matched Optic Yellow™

SEAM STITCH COR COMP.  
SST Red .47 300 lbs.



AVAILABLE IN RETAIL PACK

STOCK NO.  
WTA9106TASA-LOW WTA9306TASA-LOW

## USSSA®

### USA SERIES

STOCK NO.  
WTA9033BUSSFPYB: 12"  
WTA9233BUSSFPYB: 11"

COVER  
Leather  
Freq. Matched Optic Yellow™

SEAM STITCH COR COMP.  
SST Blue .47 375 lbs.

CENTER  
Compression Controlled Polycore



### USA SERIES®

STOCK NO.  
WTA9133BUSSFPYB: 12"  
WTA9333BUSSFPYB: 11"

COVER  
Synthetic Leather  
Freq. Matched Optic Yellow™

SEAM STITCH COR COMP.  
SST Blue .47 375 lbs.

CENTER  
Compression Controlled Polycore



## YOUTH LEAGUE

### LITTLE LEAGUE®

STOCK NO.  
WTA9074BSST: 12"  
WTA9274BSST: 11"

COVER  
Leather  
Freq. Matched Optic Yellow™

SEAM STITCH COR COMP.  
SST Red .47 375 lbs.

CENTER  
Compression Controlled Polycore



Little League.

### PONY® LEAGUE

STOCK NO.  
WTA9075BSST: 12"  
WTA9275BSST: 11"

COVER  
Leather  
Freq. Matched Optic Yellow™

SEAM STITCH COR COMP.  
SST Red .47 375 lbs.

CENTER  
Compression Controlled Polycore



## TRAINING

### RECREATIONAL

STOCK NO.  
WTA9150T: 12"

COVER  
Synthetic Leather  
Freq. Matched Optic Yellow™

SEAM STITCH  
Flat Red

CENTER  
Compression Controlled Cork

STOCK NO.  
WTA9250T: 11"

COVER  
Synthetic Leather  
Freq. Matched Optic Yellow™

SEAM STITCH  
Flat Red

CENTER  
Compression Controlled Cork



### SOFT COMPRESSION

STOCK NO.  
WTA9117B: 12"  
WTA9317B: 11"

COVER  
Ultra Grip™  
Freq. Matched Optic Yellow™

SEAM STITCH LEVEL  
SST Red 1

CENTER  
Sponge Center

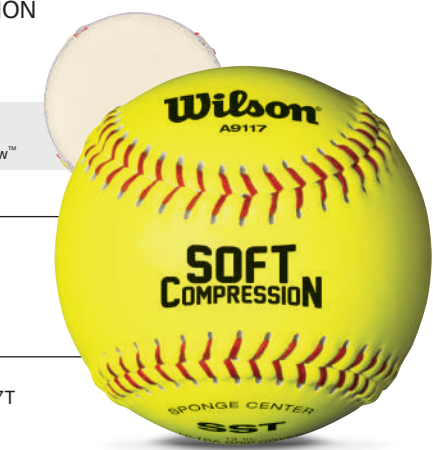

AVAILABLE IN RETAIL PACK

STOCK NO.  
WTA9117T WTA9317T

### BALL BUCKET WITH LID

STOCK NO.  
WTA394700

Holds 2 Dozen Softballs





## USA SOFTBALL®

### RAZZO

STOCK NO. WTDRZOL11AB: 11"

COVER  
LEATHER OPTIC YELLOW™

STITCH COR COMP.  
RED .44 375 LBS.

STOCK NO. WTDRZOS11AB: 11"

COVER  
SYNTH. LEATHER OPTIC YELLOW™



REQUIREMENTS:  
.44 COR;  
375 LBS. MAX. COMP.

### RAZZO +

STOCK NO. WTDRZPL12AB: 12"

COVER  
LEATHER OPTIC YELLOW™

STITCH COR COMP.  
RED .52 300 LBS.

STOCK NO.  
WTDRZPS12AB: 12"  
WTDRZPS11AB: 11"

COVER  
SYNTH. LEATHER OPTIC YELLOW™



REQUIREMENTS:  
.52 COR;  
300 LBS. MAX. COMP.

## NSA® SERIES

STOCK NO. WTA9071BNSA: 12"

COVER  
LEATHER OPTIC YELLOW™

STITCH  
BLACK

STOCK NO.  
WTA9171BNSA: 12"  
WTA9371BNSA: 11"

COVER  
SYNTH. LEATHER OPTIC YELLOW™



STOCK NO. WTA9471BNSA: 12"

COVER  
LEATHER OPTIC YELLOW™

STITCH  
BLACK

STOCK NO.  
WTA9171BNSA: 12"  
WTA9371BNSA: 11"

COVER  
SYNTH. LEATHER OPTIC YELLOW™



## USSSA® SERIES

### RAZZO | M

STOCK NO. WTDRZML12UB: 12"

COVER  
LEATHER OPTIC YELLOW™

STITCH COR COMP.  
BLUE .40 325 LBS.

STOCK NO. WTDRZMC12UB: 12"

COVER  
COMPOSITE OPTIC YELLOW™

STOCK NO. WTDRZMS12UB: 12"

COVER  
SYNTH. LEATHER OPTIC YELLOW™



USSSA® REQUIREMENTS  
MEN'S CLASSIC M: .40 COR;  
325 LBS. MAX. COMPRESSION

### RAZZO | W

STOCK NO. WTDRZWL11UB: 11"

COVER  
LEATHER OPTIC YELLOW™

STITCH COR COMP.  
BLUE .44 400 LBS.

STOCK NO. WTDRZWS11UB: 11"

COVER  
SYNTH. LEATHER OPTIC YELLOW™



USSSA® REQUIREMENTS  
WOMEN'S CLASSIC W: .44 COR;  
400 LBS. MAX. COMPRESSION

### RAZZO | Y

STOCK NO. WTDRZYL12UB: 12"

COVER  
LEATHER OPTIC YELLOW™

STITCH COR COMP.  
BLUE .52 300 LBS.

STOCK NO. WTDRZYS12UB: 12"

COVER  
SYNTH. LEATHER OPTIC YELLOW™



USSSA® REQUIREMENTS:  
.52 COR;  
300 LBS. MAX. COMPRESSION

### NEW DISTANCE

STOCK NO. WTDRZDC12AB: 12"

COVER  
COMPOSITE LEATHER

STITCH COR COMP.  
RED .44 375 LBS.



## WINDY CITY SERIES

### WINDY CITY™

STOCK NO.  
WTA9266B: 16"

COVER  
Leather

SEAM  
Flat

CENTER  
Compression Controlled Cork



windy city



# GEAR BAGS

## SECTION BRANDS

DEMARINI  
LOUISVILLE SLUGGER  
EVOSHIELD  
WILSON

2022

GEAR BAGS



## NEW SPECTRE BACKPACK

ARTICLE	COLOR	MSRP
WB5717601	Black	\$119.95
WB5717602	Heather Grey	
WB5717603	Navy	

DIMENSIONS 13.5" W x 8.5 D x 24" H

- EXTRA-LARGE MAIN COMPARTMENT
- NEOPRENE BAT SLEEVES Holds 4 bats
- INTERIOR SHELF With snap reinforcement
- FLEECE LINED VALUABLES POCKETS With internal organizational pockets
- LARGE THERMAL FOIL LINED POCKET For drinks and snacks
- PADDED SHOULDER STRAPS And back paneling
- FINGER LOOP Zipper pulls
- REMOVABLE DECORATION PANEL
- INTEGRATED Fence hooks (2)



## VOODOO XL BACKPACK

ARTICLE	COLOR	MSRP
WB5710801	Black	\$89.99
WB5710802	Navy	
WB5710803	Royal	
WB5710804	Scarlet	
WB5710805	Team White	
WB5710806	USA	

DIMENSIONS 13.25" W X 12.50" D X 22.50" H

- LARGE MAIN COMPARTMENT Fits helmet, glove and gear
- PERFORATED NEOPRENE BAT SLEEVES Holds up to 2 bats
- MESH WATER BOTTLE SLOT Can be utilized to hold an additional bat
- EQUIPMENT STRAP To carry your helmet, glove or protective equipment on the outside of your bag
- FLEECE LINED Cell phone pocket
- THERMAL POCKET For your drink or game day snack
- INTEGRATED Fence hooks (2)
- WATER RESISTANT Bottom
- LARGE SIZE 10 ZIPPERS On main opening
- REMOVABLE DECORATION PANEL
- PADDED SHOULDER STRAPS And back paneling
- CORDED Zipper pulls





### VOODOO OG BACKPACK

ARTICLE	COLOR	ARTICLE	COLOR	MSRP
WB5711701	Black	WB5711709	Royal	\$69.99
WB5711702	Charcoal	WB5711710	Scarlet	
WB5711703	Dark Green	WB5711711	Team White	
WB5711704	Light Gold	WB5711712	USA	
WB5711705	Maroon	WB5711713	Victory Blue	
WB5711706	Navy	WB5711721	Cardinal	
WB5711707	Orange	WB5711722	Texas Orange	
WB5711708	Purple	WB5711723	Vegas Gold	
<b>DIMENSIONS</b> 12.25" W X 12" D X 19" H				

LARGE MAIN COMPARTMENT Fits helmet, glove and more  
 NEOPRENE BAT SLEEVES Hold up to 2 bats  
 FLEECE LINED Cell phone pocket  
 MESH WATER BOTTLE SLOT  
 SHOE COMPARTMENT  
 2 ADDITIONAL Front valuables pockets  
 INTEGRATED Fence hook (1)  
 REMOVABLE DECORATION PANEL  
 WATER RESISTANT Bottom  
 PADDED SHOULDER STRAPS And back paneling  
 CORDED Zipper pulls



### VOODOO JUNIOR BACKPACK

MODEL NO.	DIMENSIONS	MSRP
WTD9106	11.5" W X 9" D X 17" H	\$34.99

LARGE MAIN COMPARTMENT Fits helmet, glove and gear  
 MESH BAT SLEEVES Holds up to 2 bats and doubles as water bottle holders  
 VALUABLES POCKET  
 INTEGRATED Fence hook (1)  
 PADDED Shoulder straps and back  
 CUSTOMIZATION AREA



### NEW SPECTRE WHEELED BAG

ARTICLE	DIMENSIONS	MSRP
WB5717701	38" L x 18" W x 11" H	\$299.95

PADDED BAT SLEEVES Holds 6 bats  
 REINFORCED Side walls  
 INTERNAL SHELVES With snap reinforcement  
 LARGE THERMAL FOIL LINED POCKET For drinks and snacks  
 FLEECE-LINED VALUABLES POCKET  
 HARD BODY CONSTRUCTION  
 TELESCOPIC PULL HANDLE  
 INTERIOR ZIPPERED Mesh pockets  
 SEPARATE INTERIOR BAG For small accessories  
 INLINE WHEELS For smooth roll  
 SIZE 10 ZIPPERS AND FINGER LOOP PULLS On main compartments  
 2 J-STYLE FENCE HOOKS  
 REMOVABLE DECORATION PANEL



### NEW SPECIAL OPS® FRONT LINE WHEELED BAG

ARTICLE	COLOR	MSRP
WB5710901	Black	\$229.95
WB5710902	Navy	
WB5710904	USA	

**DIMENSIONS** 38" L x 13.5" W x 11" H

ARMORED BAT COMPARTMENT Holds up to 4 bats (4 individual slots)  
 BREATHABLE Shoe compartment  
 HEAVY DUTY INTERIOR SHELVES Reinforced with snaps  
 HARD BODY CONSTRUCTION  
 INLINE WHEELS  
 TELESCOPING PULL HANDLE  
 6 ADDITIONAL EXTERIOR POCKETS With 1 fleece lined pocket  
 SIZE 10 ZIPPERS On main openings of bag  
 2 FENCE HOOKS  
 2 BOTTOM RAILS  
 FINGER LOOP Zipper pulls  
 PADDED TUBULAR WEBBING Front load handles  
 RUBBERIZED 3D LOGO  
 REMOVABLE EMBROIDERY PANEL  
 PERFECT SIZE FOR ALL LEVEL BALL PLAYERS Youth leagues to adult slowpitch



### MOMENTUM™ WHEELED BAG 2.0

MODEL NO.	DIMENSIONS	MSRP
WTD9506	36" L X 12" W X 12" H	\$89.99

BAT SLEEVES Holds up to 4 bats  
 INTERIOR SHELVES (2) To separate players glove or cleats from other gear  
 SIDE ACCESSORY POCKET  
 INTERIOR L BRACKET To help prevent bag blowouts  
 INLINE WHEELS For smooth roll  
 INTEGRATED Fence hooks (2)  
 REMOVABLE DECORATION PANEL





REMOVABLE CUSTOMIZATION PANEL

### NEW PRIME STICK PACK 2.0

ARTICLE	COLOR	MSRP
WB5711001	Black	\$109.95
WB5711002	Navy	
WB5711003	Royal	
WB5711004	Scarlet	
WB5711005	Team White	

DIMENSIONS 14" W X 9" D X 24" H

- MAIN COMPARTMENT WITH INTERIOR SHELF FITS HELMET, GLOVE, GEAR AND MORE
- NEOPRENE BAT SLEEVES HOLD 4 BATS
- FLEECE LINED VALUABLES POCKET
- 3 ADDITIONAL OUTSIDE ACCESSORIES POCKETS
- WATER RESISTANT BOTTOM
- 2 FENCE CLIPS
- REMOVABLE DECORATION PANEL
- PADDED BACKING AND SHOULDER STRAPS



### SELECT PWR STICK PACK

MODEL NO.	DIMENSIONS	MSRP
WTL9703	12" W X 9" D X 20" H	\$69.99

- LARGE MAIN COMPARTMENT FITS HELMET, GLOVE AND MORE
- BAT SLEEVES 2 NEOPRENE SLEEVES
- FLEECE LINED CELL PHONE POCKET
- OUTSIDE SHOE POUCH WITH WITH ADJUSTABLE SPEED BUCKLES
- DURABLE J-STYLE FENCE HOOK
- FOAM PADDED SHOULDER STRAPS
- REMOVABLE CUSTOMIZATION PANEL



REMOVABLE CUSTOMIZATION PANEL



REMOVABLE CUSTOMIZATION PANEL

### NEW OMAHA STICK PACK

ARTICLE	COLOR	MSRP
WB5717501	Black	\$39.99
WB5717502	Charcoal	
WB5717503	Navy	
WB5717504	Royal	
WB5717505	Scarlet	

DIMENSIONS 13" W X 8" D X 20" H

- MAIN COMPARTMENT FITS HELMET, GLOVE AND GEAR
- BAT SLEEVES WITH STRETCH PANEL HOLD TWO BATS
- SHOE POCKET
- VALUABLES POCKET
- DURABLE J-STYLE FENCE HOOK
- REMOVABLE DECORATION PANEL
- CORDED ZIPPER PULLS



CUSTOMIZATION AREA

### GENUINE STICK PACK

MODEL NO.	DIMENSIONS	MSRP
WTL9302	9" W X 11" D X 17" H	\$29.99

- MAIN COMPARTMENT FITS HELMET, GLOVE AND YOUTH CLEATS
- BAT SLEEVES HOLDS UP TO 2 FULL SIZE BATS
- ZIPPERED VALUABLES POCKET
- DURABLE J-STYLE FENCE HOOK
- FOAM PADDED SHOULDER STRAPS
- CUSTOMIZATION AREA





### GENUINE MLB® STICK PACK

MODEL NO.	DIMENSIONS	MSRP
WTL9302TC	9" W X 11" D X 17" H	\$34.99

- MAIN COMPARTMENT FITS HELMET, GLOVE AND YOUTH CLEATS
- BAT SLEEVES HOLDS UP TO 2 FULL SIZE BATS
- ZIPPERED VALUABLES POCKET
- DURABLE J-STYLE FENCE HOOK
- FOAM PADDED SHOULDER STRAPS
- MLB® BRANDING

#### AL EAST



NEW YORK YANKEES WTL9302TCNY  
 BOSTON RED SOX WTL9302TCBOS  
 BALTIMORE ORIOLES WTL9302TCBAL  
 TAMPA BAY RAYS WTL9302TCFB  
 TORONTO BLUE JAYS WTL9302TCOR

#### NL EAST



ATLANTA BRAVES WTL9302TCATL  
 MIAMI MARLINS WTL9302TCMIA  
 NEW YORK METS WTL9302TCNYM  
 PHILADELPHIA PHILLIES WTL9302TCPHI  
 WASHINGTON NATIONALS WTL9302TCWSH

#### AL CENTRAL



CLEVELAND INDIANS WTL9302TCCL  
 CHICAGO WHITE SOX WTL9302TCWCS  
 DETROIT TIGERS WTL9302TCDET  
 KANSAS CITY ROYALS WTL9302TCKC  
 MINNESOTA TWINS WTL9302TCMIN

#### NL CENTRAL



CHICAGO CUBS WTL9302TCCB  
 CINCINNATI REDS WTL9302TCCIN  
 MILWAUKEE BREWERS WTL9302TCMIL  
 PITTSBURGH PIRATES WTL9302TCPIT  
 ST. LOUIS CARDINALS WTL9302TCSL

#### AL WEST



HOUSTON ASTROS WTL9302TCHOU  
 LOS ANGELES ANGELS WTL9302TCLA  
 OAKLAND ATHLETICS WTL9302TCAOK  
 SEATTLE MARINERS WTL9302TCSEA  
 TEXAS RANGERS WTL9302TCTEX

#### NL WEST



ARIZONA DIAMONDBACKS WTL9302TCARI  
 COLORADO ROCKIES WTL9302TCCOL  
 LOS ANGELES DODGERS WTL9302TCLAD  
 SAN FRANCISCO GIANTS WTL9302TCSF  
 SAN DIEGO PADRES WTL9302TCSD

### OMAHA RIG WHEELED BAG

MODEL NO.	COLOR	MSRP
WTL9505	35" L X 12" W X 12" H	\$79.99

- MAIN COMPARTMENT FITS HELMET, GLOVE AND GEAR
- ZIPPERED BAT COMPARTMENT WILL HOLD 4 BATS COMFORTABLY
- TWO INTERIOR SHELVES TO HELP WITH GEAR WEIGHT BALANCE THROUGHOUT THE BAG
- OUTSIDE VALUABLES POCKET FOR CELL PHONE
- INTERIOR L BRACKET TO HELP PREVENT BAG BLOWOUTS
- INLINE WHEELS FOR SMOOTH ROLL
- INTEGRATED FENCE HOOKS [2]
- REMOVABLE CUSTOMIZATION PANEL



REMOVABLE  
CUSTOMIZATION  
PANEL



### NEW EXEC BACKPACK

ARTICLE	COLOR	MSRP
WB5717801	Black	\$99.95
WB5717802	Navy	
WB5717803	Olive	

DIMENSIONS 11.5" W X 7" D X 19.75" H

COATED RECYCLED POLYESTER FABRIC

LARGE MAIN COMPARTMENT For everyday use

FLEECE LINED ACCORDION Organizational pocket

PADDED TABLET COMPARTMENT With pen loop and key leash

VENTED Padded laptop compartment

TWO EXTERNAL WATER BOTTLE COMPARTMENTS

REAR LUGGAGE LOOP



BLACK 01  
 NAVY 02  
 OLIVE 03

### PLAYERS DUFFLE

MODEL NO.	DIMENSIONS	MSRP
WTV9301	26" L X 13" W X 13" H	\$79.99

MAIN COMPARTMENT Fits helmet, gloves, gear and more

VENTED Shoes or wet gear compartment with drop lining

FLEECE LINED Cell phone pocket

DIVIDED BAT SLEEVES Compartment holds 2 bats

TUBULAR WEBBING On outside of the bag for elbow and leg guards

COMPOSITE TREATED BOTTOM To protect against the elements

PADDED CARRY HANDLE And fence hook

SHOULDER STRAP With swivel speed clips

PREMIUM MOLDED EvoShield logo

REMOVABLE CUSTOMIZATION PANEL



BL NA RO SC



REMOVABLE  
CUSTOMIZATION  
PANEL



NEW COLORS

REMOVABLE CUSTOMIZATION PANEL

### STANDOUT BACKPACK

MODEL NO.	DIMENSIONS	MSRP
WTV9101	12" W X 9" D X 23" H	\$79.99

MAIN COMPARTMENT Fits helmet, gloves and gear  
 VENTED Shoe compartment  
 FLEECE LINED Cell phone pocket  
 2 NEOPRENE BAT SLEEVES With elastic straps  
 TUBULAR WEBBING On outside of the bag for elbow and leg guards  
 DURABLE J-Style fence hook  
 PADDED MESH BACKING And shoulder straps  
 REMOVABLE Decoration panel  
 PREMIUM MOLDED EvoShield logo



REMOVABLE CUSTOMIZATION PANEL

### NEW SRZ-1™ BACKPACK

ARTICLE	COLOR	MSRP
WB5717901	Black	\$49.99
WB5717902	Charcoal	
WB5717903	Navy	
WB5717904	Royal	
WB5717905	Scarlet	
WB5717906	USA	

DIMENSIONS 12" W X 9" D X 18" H

MAIN COMPARTMENT Holds youth glove, helmet and additional gear  
 2 MESH BAT SLEEVES That can double up as water bottle slots  
 FRONT VALUABLES POCKET  
 TWO TUBULAR WEBBING LOOPS For Protective Elbow and Leg Guard or Batting Gloves  
 HIDDEN DURABLE J-STYLE Fence hook  
 FRONT DECORATION PANEL  
 CORDED Zipper pulls



REMOVABLE CUSTOMIZATION PANEL



### STONEWALL WHEELED BAG

MODEL NO.	DIMENSIONS	MSRP
WTV9400	38" L X 17" W X 12" H	\$199.95

MAIN COMPARTMENT Fits a whole set of catcher's gear, batting helmet and more  
 FITS 4 bats comfortably  
 EXTERIOR SLIP POCKET With bloused lining to store shin guards  
 VENTED SHOE COMPARTMENT With drop lining  
 HIGH RISE WHEEL CHASSIS With inline wheels for smooth roll  
 ACCESSORY POCKET With hidden mesh zippered pocket  
 FLEECE LINED Zippered cell phone pocket  
 TELESCOPIC Pull handle  
 PREMIUM MOLDED EvoShield logo  
 REMOVABLE CUSTOMIZATION PANEL



REMOVABLE CUSTOMIZATION PANEL



### NEW STANDOUT WHEELED BAG

ARTICLE	DIMENSIONS	MSRP
WB5719101	Black	\$149.95
WB5719102	Charcoal	
WB5719103	Navy	
WB5719104	Royal	
WB5719105	Scarlet	

DIMENSIONS 38" L X 14" W X 14" H

LARGE MAIN COMPARTMENT Fits helmet, glove, and cleats and complete set of catcher's gear  
 INDIVIDUALLY Padded bat sleeves  
 REINFORCED INTERNAL SHELF  
 WHEEL CHASSIS 3" clearance and inline wheels  
 EXTENDED BOTTOM RAILS With PE Board backing  
 2 INTEGRATED fence hooks  
 2 EXTERNAL valuables pockets  
 INTERNAL ZIPPERED mesh pocket  
 REMOVABLE DECORATION PANEL  
 PLASTIC CORNER CATERPILLARS To add reinforcement





### NEW A2000® BACKPACK

ARTICLE	COLOR	MSRP
WB5718001	Charcoal	\$109.95
WB5718003	Olive	

**DIMENSIONS** 11.5" W X 6.75" D X 19.25" H

- LARGE MAIN COMPARTMENT** For everyday use
- DURABLE CORDURA POLYESTER** shell fabric
- PADDED** Laptop and tablet compartment
- INTERNAL MESH** Water bottle pocket
- LUGGAGE LOOP**
- FLEECE** Valuables pocket
- SMALL ACCESSORY POCKET** With key leash
- CORDED ZIPPER PULLS** With leather details
- YKK VISLON** Zippers
- SEATBELT WEBBING**
- MOLDED BACK** With thick ergonomic shoulder straps
- EXTERNAL A2000 GLOVE LOOP**



CHARCOAL 01 OLIVE 03



### NEW BALL BUCKET BAG

ARTICLE	DIMENSIONS	MSRP
WB5710701	27" L X 14.5" D X 20.50" H	\$159.95

- MAIN COMPARTMENT** Holds 2 Six gallon bucket of baseballs or softballs
- MOLDED FOAM BASED BOTTOM** Secure to buckets from shifting during transportation
- ADJUSTABLE INTERIOR WEBBING STRAP** To secure buckets in place
- 3 EXTERIOR POCKETS** For score book and other small accessories
- LARGE WHEELS** For smooth roll
- 2 LOAD HANDLES** For easy loading in and out of vehicles
- 2 BOTTOM RAILS**
- SKID PLATE BETWEEN WHEELS** To prevent abrasion
- TELESCOPIC PULL HANDLE**
- REMOVABLE DECORATION PANEL**



BL 01



CUSTOMIZATION AREA

### TEAM GEAR BAG ON WHEELS

ARTICLE	DIMENSIONS	MSRP
WTA9710BL	39.5" L X 14" W X 15" H	\$69.99

- OVERSIZED** Multi-purpose gear bag
- RIG BOTTOM** With support rails and interior support bracket
- FITS MULTIPLE** Helmets, bats and set of catcher's gear
- CUSTOMIZATION AREA**



REMOVABLE CUSTOMIZATION AREA

### WILSON® TEAM GEAR BAG ON WHEELS

MODEL NO.	DIMENSIONS	MSRP
WTA9709	40" L X 14.5" W X 13" H	\$49.99

- EXTRA LARGE MAIN COMPARTMENT** Fits helmet, gloves, cleats & a complete set of catcher's gear
- SEPARATE VENTILATED COMPARTMENT** For shoes, wet gear or catcher's helmet
- #8 ZIPPERS** On main opening
- HANDLES** On both sides for easy loading
- REMOVABLE CUSTOMIZATION PANEL**



### WHEELED UMPIRE BAG

ARTICLE	DIMENSIONS	MSRP
WTA9780BL	36" L X 16" W X 15" H	\$159.99

- SEPARATE UPPER AND LOWER COMPARTMENTS** Allow you to separate gear from clothing
- SEPARATE VENTED** Shoe compartment
- COMFORT-GRIP CARGO HANDLE** For easy pulling
- INLINE WHEELS WITH RAILS** Attached to wheel housing for added support
- INTERIOR POCKET** For umpire accessories
- PVC CORNER STOPS** For durability
- OFFICIAL UMPIRE GEAR OF MLB®**





2022

# ATEC SPORTS

SECTION BRANDS

ATEC



WWW.ATECSPORTS.COM

OFFICIAL PITCHING MACHINE  
OF MAJOR LEAGUE BASEBALL

# M3X™ THE ONLY MACHINE YOU'LL EVER NEED.

## OFFENSE

- High Pitch Speeds: 90+ MPH [BB] and 70+MPH [SB]
- Throws up to 5 Pitch Types
- Mound-to-Plate Pitch Distance
- Release-point pitch height
- Pitches from both RHP & LHP
- Compatible with any type of ball

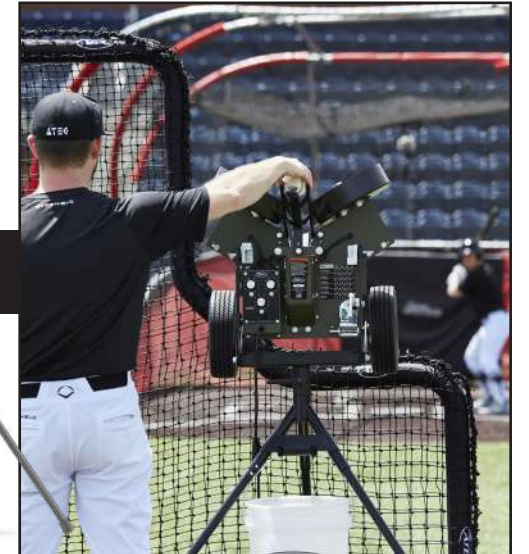
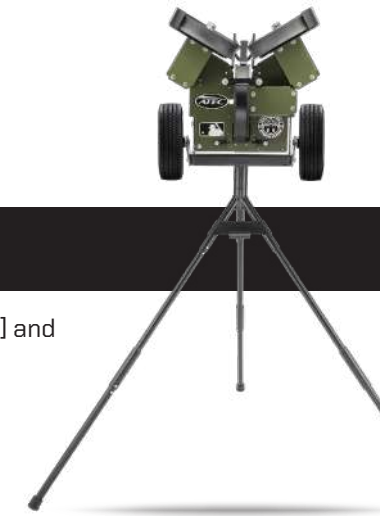

## DEFENSE

- Top-Spin Ground Balls
- Full-Field Fungo: 350 FT. [BB] and 240 FT. [SB] Fly Balls
- Hooking & Slicing Line Drives
- Catcher's Pop Ups

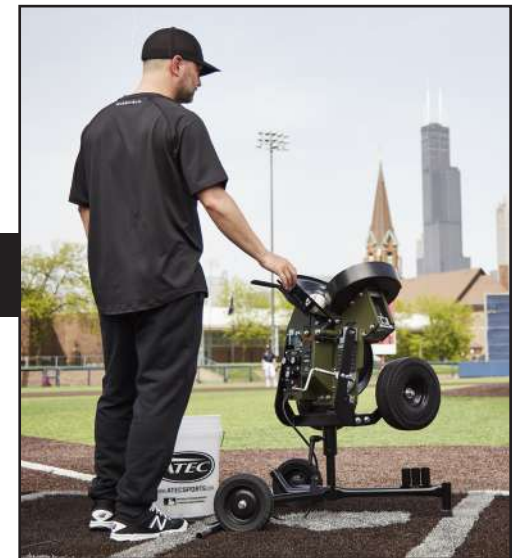

## PORTABLE & VERSATILE

- Heavy Duty Wheels
- 3 Base Options
- Easy Conversion between Baseball & Softball
  - (No Additional Parts Needed)



# M3X™

CLASS: OFFENSIVE & DEFENSIVE PITCHING MACHINE

LEVEL: PROFESSIONAL



M3X CLASS OFFENSE DEFENSE

PROFESSIONAL  
LEVEL COLLEGIATE  
TRAVEL

The all-new M3X training machine is the first all-in-one crossover pitching machine of its kind. Designed as a smaller, more portable version of the M3 machine, the M3X contains all the same functionality as the M3, while combining the same features of the defensive R-Series machines by ATEC®

The all-in-one M3X crossover machine is also able to be converted to a fastpitch softball machine, by moving the motor placements to the outside settings, the M3X machine can be switched from throwing baseballs to softballs in minutes!

**Offensive Pitching:** Based off the ATEC® M3 machine, by utilizing three wheels, top speed, accuracy, and spin are maximized due to the ball's increased surface contact with the wheels. The M3X is equipped to throw 90mph giving you the ability to train against Major League level fastballs and both right and left handed breaking balls. Using only the speed control knobs, pitches can easily be dialed-in without making any physical adjustments to the machine, helping you improve the efficiency and effectiveness of your batting practice.

**Defensive Training:** Combining the functionality of the R-Series machines also give the M3X the ability to swivel 360 degrees, and control elevation from ground balls and fly balls in a split second. This gives the user the ability to execute hundreds of ground balls, line drives, fly balls and pop-ups in a single practice, giving your players more quality repetitions than could possibly be achieved with only a fungo bat.

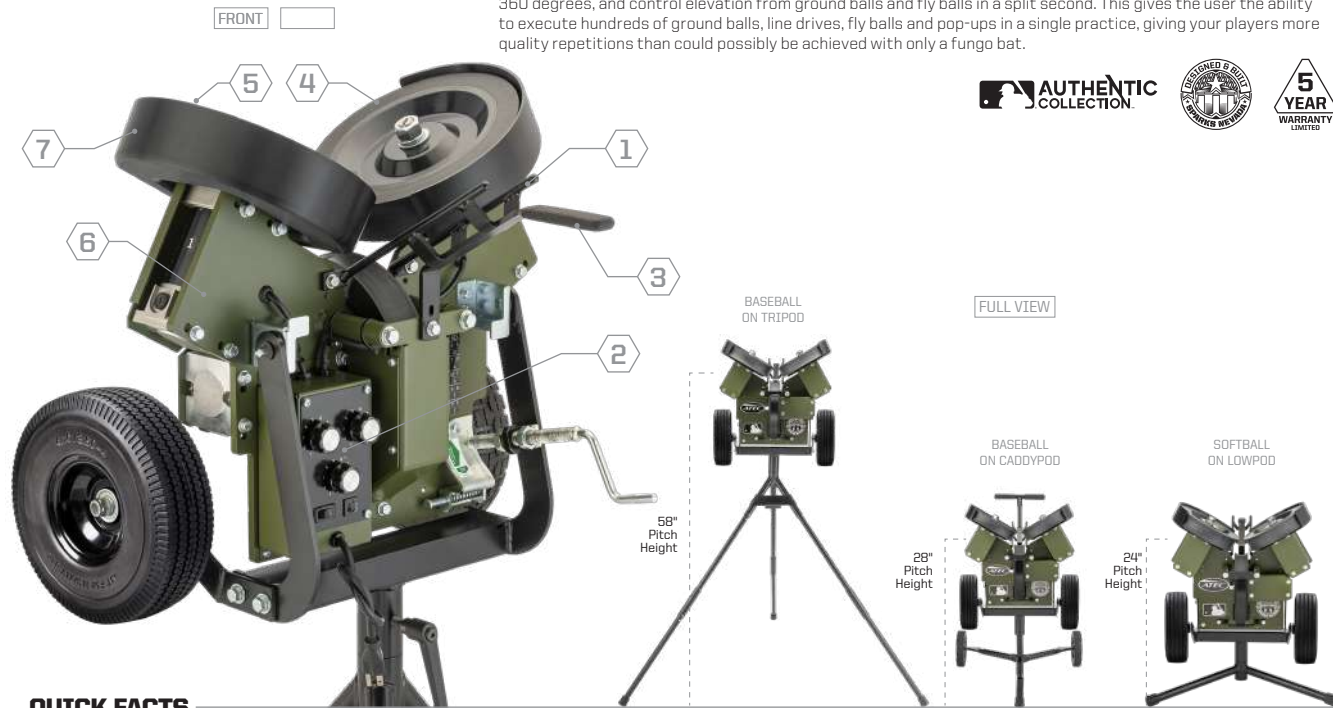

**QUICK FACTS**

TOP SPEED: **90 MPH**

PITCHES THROWN: FB (FASTBALL), CB (CURVEBALL), SL (SLIDER), SP (SPLITTER), KN (KNUCKLEBALL)

COMPATIBLE BALL TYPES: LEATHER, DIMPLE, FOAM

**PRODUCT FEATURES**

- High Definition Ball Chute**
    - With an uninterrupted view of the ball for a Live-Arm sense of timing
  - Speed Control Dials**
    - To quickly change between fastballs and breaking balls
  - Full Control Fungo System (FCFS)**
    - Maximizes your defensive ball placement and control
  - Concave Wheel Treads**
    - Increase ball grip and maximize pitch accuracy
  - Dual Durometer Wheel Hubs**
    - Increase maximum pitch speed and minimize recovery time
  - Durable Steel Frame**
    - And wide base tripod absorb machine recoil for maximum accuracy
  - ABS Wheel Guards**
    - Help protect the operator and the machine wheels
- Ball Compatibility**
- Regulation leather balls, rubber dimple, and foam machine baseballs and softballs

**PRODUCT SPECS.**

SPORT	STOCK NO.	BASE	MSRP
BB	WTATMM3BTX	Tripod	\$2,649.95
BB	WTATMM3BCX	Caddy	\$2,649.95
SB	WTATMM3SLX	Lowpod	\$2,649.95
SB	WTATMM3SCX	Caddy	\$2,649.95

	Baseball - M3BTX/CX	Softball - M3SLX/CX
Ball Size	Baseball: 9"	Softball: 12"
Ball Types	Leather, Dimple & Foam	Leather, Dimple & Foam
Speed Range	30-90 MPH	30-75 MPH
Max Fly Ball Dist.	340 FT	240 FT
Pitch Height	58 IN	24 IN
Base Type	Tripod	Lowpod
Footprint	1260 IN²	340 IN²
Weight	115 LBS	100 LBS
Power Supply	110v AC	110v AC
Generator Use	1800w CD	1800w CD

# M3™

CLASS: OFFENSIVE PITCHING MACHINE

LEVEL: PROFESSIONAL



M3 CLASS OFFENSE DEFENSE

PROFESSIONAL  
LEVEL COLLEGIATE  
TRAVEL

The M3 Offensive Pitching Machine is built to train professional level ballplayers. Its industry leading 3-wheel design allows for hitters to have complete visibility of the ball throughout the entire pitch cycle, which improves their timing and increases their pitch recognition. By utilizing three concave wheels; top speed, accuracy, and spin are maximized due to the ball's increased surface contact with the wheels. The M3 is equipped to throw 105mph giving you the ability to train against Major League level fastballs and both right and left handed breaking balls. Using the speed control knobs, pitches can easily be dialed-in, helping you improve the efficiency and effectiveness of your batting practice. The M3 is the Official Machine of Major League Baseball®



**QUICK FACTS**

TOP SPEED: **105 MPH**

PITCHES THROWN: FB (FASTBALL), CB (CURVEBALL), SL (SLIDER), SP (SPLITTER), KN (KNUCKLEBALL)

COMPATIBLE BALL TYPES: LEATHER, DIMPLE, FOAM

**PRODUCT FEATURES**

- High Definition Ball Chute**
    - Players have a clear and uninterrupted view of the ball throughout the entire pitch cycle
    - Hitters see when to stride and achieve a live-arm sense of timing for the most realistic repetitions
  - Quick-Pitch-Select**
    - Change quickly between Major League level fastballs and breaking balls using the speed control dials
  - Concave Dual-Durometer Wheels**
    - Increase ball grip to maximize pitch accuracy of both fastballs and breaking balls
    - Faster acceleration than standard wheels, increasing maximum pitch speed and minimizing recovery time
  - Durable Steel Frame**
    - Rugged frame and wide-base tripod absorb machine recoil ensuring maximum accuracy of every pitch
  - ABS Wheel Guards**
    - Helps protect operator and wheels during use
- Real Ball Compatibility**
- Compatible for use with leather baseballs as well as dimpled and foam machine baseballs

**PRODUCT SPECS.**

SPORT	STOCK NO.	BASE	MSRP
BB	WTATMM3BT	Tripod	\$3,199.95

	Baseball - M3BT
Ball Size	Baseball: 9"
Ball Types	Leather, Dimple & Foam
Speed Range	30-105 MPH
Recovery Time	8 SEC
Pitch Height	60 IN
Base Type	Tripod
Footprint	1260 IN²
Weight	125 LBS
Power Supply	110v AC
Generator Use	1800w CD

# M2™

CLASS: OFFENSIVE PITCHING MACHINE

LEVEL: COLLEGIATE



M2

CLASS OFFENSE DEFENSE

PROFESSIONAL

COLLEGIATE

TRAVEL

The M2 Offensive Pitching Machine, formerly called the 'Casey Pro', is built to train collegiate level ballplayers. When it comes to accuracy, power and portability, no other 2-wheel machine is better equipped than the M2. With the ability to pitch 90mph, the M2 can throw collegiate level fastballs, curveballs and sliders to any spot in the strike zone. The M2 is used and trusted by many nationally ranked college programs to develop their elite players and take their hitting abilities to the next level.



### QUICK FACTS

TOP SPEED

90 MPH

PITCHES THROWN



COMPATIBLE BALL TYPES



### PRODUCT FEATURES

- 1. Concave A.H.Wheels**
    - Concave tread increases ball grip to maximize pitch accuracy of both fastballs and curve balls
  - 2. Quick Change Tilt System**
    - Gives you the ability to throw both collegiate level fastballs and right and left handed curve balls
    - Allows the machine's head to tilt and change the axis of rotation on the pitched ball
  - 3. Durable Steel Frame**
    - Rugged frame and wide-base tripod absorb machine recoil ensuring maximum accuracy of every pitch
  - 4. Built-in transport wheels**
    - Integrated injection molded wheels promote maximum mobility and ease of storage
  - 5. Vertical Micro Adjuster (Add on Feature)**
    - Upgrade M2 machine with vertical micro adjuster, which allows ball pitch location to be adjusted 36" up/down during hitting session while making no major adjustments to the machine set up
- Real Ball Compatibility**
- Compatible for use with leather balls as well as dimpled and foam machine balls

### PRODUCT SPECS.

SPORT	STOCK NO.	BASE	MSRP
BB	WTATMM2BT	Tripod	\$2,199.95
SB	WTATMM2SL	Lowpod	\$2,199.95

**M2 WITH VERTICAL MICRO ADJUSTER**

SPORT	STOCK NO.	MSRP
BB	WTATMM2BT3G	\$2,299.95
SB	WTATMM2SL3G	\$2,299.95

	Baseball-M2BT	Softball-M2SL
Ball Size	Baseball: 9"	Softball: 12"
Ball Types	Leather, Dimple & Foam	Leather, Dimple & Foam
Speed Range	30-90 MPH	30-90 MPH
Recovery Time	8 SEC	8 SEC
Pitch Height	60 IN	25 IN
Base Type	Tripod	Lowpod
Footprint	1260 IN <sup>2</sup>	340 IN <sup>2</sup>
Weight	110 LBS	90 LBS
Power Supply	110v AC	110v AC
Generator Use	1200w CD	1200w CD

# M1.J™

CLASS: OFFENSIVE PITCHING MACHINE

LEVEL: TRAVEL



M1.J

CLASS OFFENSE DEFENSE

PROFESSIONAL

COLLEGIATE

TRAVEL

The all new M1.J is the fastball only version of the popular M1 pitching machine. This machine is great for younger age groups and machine pitch leagues, with its lightweight portability and easy setup. With speeds of 30-70 MPH, this will allow the machine user to throw a straight fastball to match any player's abilities. It's built using the same technology, processes and materials as ATEC's other industry leading training machines. Similar to other high-end ATEC® machines, the M1.J is also equipped with a dual-durometer concave wheel. This wheel is engineered to increase the wheel's grip on the ball which maximize both pitch speed and accuracy. The M1.J also features a tilting throwing head, which allows the machine to throw ground balls and fly balls. This machine is the perfect addition for any team looking to improve all areas of their game!



### QUICK FACTS

TOP SPEED

70 MPH

PITCHES THROWN



COMPATIBLE BALL TYPES

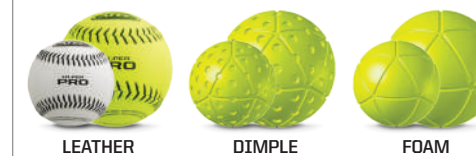

### PRODUCT FEATURES

- 1. Concave Wheel Tread**
    - Increases ball grip to maximize pitch speed and accuracy
  - 2. Dual-Durometer Wheel Hub**
    - Faster acceleration than other wheels, increasing maximum pitch speed and minimizing recovery time
  - 3. Durable Steel Frame**
    - Rugged steel frame and wide base tripod absorb machine recoil ensuring maximum accuracy every pitch
  - 4. Metal Ball Chute**
    - Durable metal ball chute will protect machine from damage from ball ricochet
- Real Ball Compatibility**
- Compatible for use with regulation leather baseballs as well as dimple and foam machine baseballs

### PRODUCT SPECS.

SPORT	STOCK NO.	BASE	PRICE
BB	WTATMM1BTJ	Tripod	\$999.95
SB	WTATMM1SLJ	Lowpod	\$999.95

	Baseball-M1BT	Softball-M1SL
Ball Size	Baseball: 9"	Softball: 12"
Ball Types	Leather, Dimple & Foam	Leather, Dimple & Foam
Speed Range	30-70 MPH	30-70 MPH
Recovery Time	8 SEC	8 SEC
Pitch Height	62 IN	25 IN
Base Type	Tripod	Lowpod
Footprint	1260 IN <sup>2</sup>	340 IN <sup>2</sup>
Weight	60 LBS	48 LBS
Power Supply	110v AC	110v AC
Generator Use	600w CD	600w CD

# R2™

CLASS: DEFENSIVE TRAINING MACHINE

LEVEL: COLLEGIATE



CLASS: OFFENSE DEFENSE

LEVEL: COLLEGIATE

M1 PROFESSIONAL TRAVEL

The R2, formerly called the **Rookie**, is built for collegiate level defensive training. It is designed to be a more compact version of the professional level R3 training machine. Both R-Series machines have the unique ability to rotate and pivot freely while the machine is on and in use, allowing you to challenge multiple fielders, playing different positions, one after another. Just like the R3, the R2 also allows you to achieve the maximum number of repetitions for any defensive drill; giving your players more quality repetitions than could possibly be achieved with only a fungo bat.



**QUICK FACTS**

TOP SPEED	MAXIMUM FLY BALL	RECOVERY TIME	WEIGHT
<b>75</b> MPH	<b>300</b> FT	<b>7</b> SEC	<b>70</b> LBS

**PRODUCT FEATURES**

- Full Control Fungo System (FCFS)**
    - Maximizes your ability to control exactly where the ball is placed during defensive drills
    - Change the ball placement of each rep, or keep it locked in to maximize repetitions of a single type
  - Hi.Per® Aluminum Discs**
    - Allows the machine to achieve the lowest recovery time possible
    - Engineered to be extremely lightweight and durable
  - High Definition Ball Chute**
    - Players have a clear and uninterrupted view of the ball throughout the entire cycle
  - Caddy pod**
    - Industry leading wheeled transport system makes set up and transitioning between drills quick and simple
  - Durable Steel Frame**
    - Rugged frame and caddy pod absorb machine recoil ensuring maximum accuracy of every pitch
- Real Ball Compatibility**
- Compatible for use with leather balls as well as dimpled and foam machine balls

COMPATIBLE BALL TYPES



**PRODUCT SPECS.**

SPORT	STOCK NO.	BASE	MSRP
BB	WTATMR2BC	Caddy pod	\$1,999.95
SB	WTATMR2SC	Caddy pod	\$1,999.95

	Baseball - R2BC	Softball - R2SC
Ball Size	Baseball: 9"	Softball: 12"
Ball Types	Leather, Dimple & Foam	Leather, Dimple & Foam
Speed Range	75 MPH	70 MPH
Recovery Time	7 SEC	7 SEC
Pitch Height	20 IN	20 IN
Base Type	Caddy pod	Caddy pod
Footprint	900 IN²	900 IN²
Weight	70 LBS	70 LBS
Power Supply	110v AC	110v AC
Generator Use	600w CD	600w CD

# BUCKET FEEDER



The Bucket Feeder is designed for use with any current ATEC® machine, as well as many older generation models. Compatible with a five or six gallon bucket, the Bucket Feeder is designed to reduce time spent between shagging balls and resuming the current training session. Perfect for coaches looking for a hands off approach for machine operation, allowing better focus on player development; or players looking for a solo training solution.



**QUICK FACTS**

FEEDER RELOAD TIME	MAX BALL CAPACITY	PITCH INTERVAL
<b>30</b> SEC	<b>60</b> BASEBALLS	<b>8</b> SEC

**PRODUCT FEATURES**

- Easy Load Design**
    - Pivoting Head allows for upright bucket loading
    - Reload Feeder with new bucket in under 30 seconds
  - Compatible with five or six gallon buckets**
    - Five Gallon = 48 Baseballs
    - Six Gallon = 60 Baseballs
- Compatible with the following ATEC machines:**
- M3™, M2™, M1™
  - R2™ (on Tripod)
  - Casey Pro 3G, Casey Pro
  - Power Hummer, Rookie
  - Axis, Radius

COMPATIBLE BALL TYPES



**PRODUCT SPECS.**

SPORT	STOCK NO.	MODEL	MSRP
BB	WTATAMFBK	Bucket Feeder	\$799.99
SB	WBA742501	Bucket Feeder	\$799.99

**COMES WITH**

- BALL BUCKET**
- BB Capacity: 4 DZ
  - SB Capacity: 2 DZ



# TRAINING BASEBALLS



Machines are only one part of what creates consistent and accurate ball flight. The balls you choose to use with your machine are the second most important factor in your training machine's accuracy, and account for roughly 30% of the accuracy equation. Our High Performance (Hi.Per®) ball line is built with numerous proprietary aerodynamic designs that maximize your training machine's accuracy. Each ball within the Hi.Per lineup is the most advanced ball in its class, helping you achieve the most consistent and accurate ball flight every time.



## Hi.Per® Pro—Leather Flat Seam Ball

(Built for Real Ball Training)

Regulation Size & Weight • Premium Full Grain Leather Cover • High-Tensile Strength AccuSeams made from Heavy-Duty Kevlar • Red Cushion Cork Center (Baseball) • Polycore Center Max. 44 CDR (Softball) • Safe for use with Performance Bats • Approved for Indoor & Outdoor Training

BASEBALL		MSRP
WTATBL01B12	1 Dozen	\$74.99



## Hi.Per® X-ACT—Dimple Ball

(Built for Maximum Machine Accuracy)

Regulation Size & Weight • Sting Blocking Construction • Xtream Aerodynamic Technology (X-ACT) Surface Design Maximizes Training Machine Accuracy • Safe for use with Performance Bats • Approved for Indoor & Outdoor Training

BASEBALL		MSRP
WTATBD02B12	1 Dozen	\$54.99



## Hi.Per® Lite—Foam Ball

(Built for High Repetition Training)

Regulation Size • ~30% Regulation Weight • Durable High-Density Foam Construction • Aerodynamically Optimized Surface Design Maximizes Training Machine Accuracy • Safe for use with Performance Bats • Approved for Indoor & Outdoor Training

BASEBALL		MSRP
WTATBF02B12	1 Dozen	\$44.99



## Hi.Per® LTD—Limited Distance Ball

(Built for Limited Space Training)



Regulation Size • Perfect for Pre-Game Warm Up • Maximum Flight Distance of ~100ft • XDC (Xtra Durable Composite) Construction Eliminates Cracking • Proprietary Tactile Surface Texture Increases Grip & Throwing Accuracy • Approved for Indoor & Outdoor Training

BASEBALL		MSRP
WTATBP02B04	4 Pack (Sold in Retail Packaging)	\$24.99
WTATBP02B12	1 Dozen (Sold in Retail Packaging)	\$49.99



## Hi.Per® POWER—Weighted Training Ball

(Built for Limited Space Training)



Regulation Size • 2.5x the Weight of Regulation Baseball • Perfect for Pre-Game Warm Up • Maximum Flight Distance of ~50ft • XDC (Xtra Durable Composite) Construction Eliminates Cracking • Approved for Indoor & Outdoor training • Not for Machine Use

BASEBALL		MSRP
WTATBW02B4	4 Pack (Sold in Retail Packaging)	\$39.99

## Buckets

### Ball Bucket

Baseball Capacity: **4 DZ**

Closed-Cell Foam Cushioned Lid • Durable Padded Handle • Semitransparent Color • 5 Gallon Volume

### Cage Bucket

Baseball Capacity: **8 DZ**

Rugged Built-In Handles for Maximum Durability • White Color • Includes Lid • 9.5 Gallon Volume

BASEBALL		MSRP
WTATABBKT	Ball Bucket	\$24.99
WTATACBKT	Cage Bucket	\$49.99



# TRAINING SOFTBALLS



Machines are only one part of what creates consistent and accurate ball flight. The balls you choose to use with your machine are the second most important factor in your training machine's accuracy, and account for roughly 30% of the accuracy equation. Our High Performance (Hi.Per®) ball line is built with numerous proprietary aerodynamic designs that maximize your training machine's accuracy. Each ball within the Hi.Per lineup is the most advanced ball in its class, helping you achieve the most consistent and accurate ball flight every time.



## Hi.Per® Pro—Leather Flat Seam Ball

(Built for Real Ball Training)

Regulation Size & Weight • Premium Full Grain Leather Cover • High-Tensile Strength AccuSeams made from Heavy-Duty Kevlar • Red Cushion Cork Center (Baseball) • Polycore Center Max. 44 CDR (Softball) • Safe for use with Performance Bats • Approved for Indoor & Outdoor Training

SOFTBALL (12")		MSRP
WTATBL02S12	1 Dozen	\$99.99



## Hi.Per® X-ACT—Dimple Ball

(Built for Maximum Machine Accuracy)

Regulation Size & Weight • Sting Blocking Construction • Xtream Aerodynamic Technology (X-ACT) Surface Design Maximizes Training Machine Accuracy • Safe for use with Performance Bats • Approved for Indoor & Outdoor Training

SOFTBALL (12")		MSRP
WTATBD02S12	1 Dozen	\$64.99



## Hi.Per® Lite—Foam Ball

(Built for High Repetition Training)

Regulation Size • ~30% Regulation Weight • Durable High-Density Foam Construction • Aerodynamically Optimized Surface Design Maximizes Training Machine Accuracy • Safe for use with Performance Bats • Approved for Indoor & Outdoor Training

SOFTBALL (12")		MSRP
WTATBF02S12	1 Dozen	\$54.99

## Buckets

### Ball Bucket

Softball Capacity: **2 DZ**

Closed-Cell Foam Cushioned Lid • Durable Padded Handle • Semitransparent Color • 5 Gallon Volume

### Cage Bucket

Softball Capacity: **3 DZ**

Rugged Built-In Handles for Maximum Durability • White Color • Includes Lid • 9.5 Gallon Volume

SOFTBALL		MSRP
WTATABBKT	Ball Bucket	\$24.99
WTATACBKT	Cage Bucket	\$49.99



# PRO BATTING TEES



**T3™ T3 WEIGHTED & T3 SHORTY:** Players use batting tees every, single, day. It is the most important piece of training equipment and our T3 tees are a staple in every Major League batting tunnel. The T3 is precisely engineered and built with industry leading materials to minimize swing interference and maximize positive contact zone feedback. The T3 lineup is designed to exceed the expectations of MLB® players and coaches. Our professional tees come with a full 1-year warranty and can quickly be set up and taken down for maximum portability.

AUTHENTIC COLLECTION



## QUICK FACTS

	MAXIMUM HEIGHT	MINIMUM HEIGHT		MAXIMUM HEIGHT	MINIMUM HEIGHT	
T3	43 IN	23 IN	1 YEAR WARRANTY LIMITED	22 IN	16 IN	T3s

## PRODUCT FEATURES

- Hi.Per® Composite Cone**
  - Helically-wrapped proprietary high performance composite minimizes swing interference and maximizes durability
  - Minimal swing interference provides optimal feedback to the hitter on every swing
- CNC Aluminum Stem**
  - Precision-milled and weather resistant aluminum maximizes performance and durability
  - Patented internal construction creates maximum friction between tiers allowing the height of the tee to remain consistent after every swing
  - Ball height can quickly be adjusted enabling the hitter to practice their mechanics on pitch heights throughout the strike zone
- High Density Base**
  - T3 Weighted Tee comes standard with 8 lb. urethane base to increase tee stability and durability. Includes carrying handle in tee base for easy transport.
  - T3 & T3s come with 2 lb. high density material base for lightweight portability
  - All T3 tee options easily detach stem and base for maximum portability

## PRODUCT SPECS.

STOCK NO.	MODEL	MSRP
WTATT3000	T3*	\$99.95
WTATT3W00	T3 Weighted	\$119.95
WTATT3S00	T3s	\$89.95
WTATT3ORP	T3 Cone Replacement	\$29.99

## T3 PROFESSIONAL BATTING TEES

- Supplied to all 30 Major League Teams

\*Sold in Retail Packaging

# TUFFY® TEE



The weighted base design provides maximum stability while allowing the batter to move the tee anywhere in their swing range. Adjustable stem and insert are designed for all heights and areas of the strike zone. Tuffy® Tees come with a 5-year limited warranty, so this tee is built to take a beating, season after season.



## QUICK FACTS

	MAXIMUM HEIGHT	MINIMUM HEIGHT	
TUFFY	40 IN	22 IN	5 YEAR WARRANTY LIMITED

## PRODUCT FEATURES

- Extremely Durable Cast Polyurethane**
  - Perfect for any age/ability
  - Able to withstand mis-hits as well as high repetition, high velocity swings
- Built in Steel Plate in Tee Base Reduces Tee movement**
  - Eliminates picking the tee up off the ground after mis-hits
- Optional Brush Tee & Adapter**
  - Reduced resistance results in accurate ball flight for training
  - Adapter to fit most tube-style tees included

## PRODUCT SPECS.

STOCK NO.	MODEL	MSRP
WTAT7375	Tuffy Tee	\$149.99
WTAT0255	Brush Tee & Adapter	\$19.99

# PROTECTIVE SCREENS

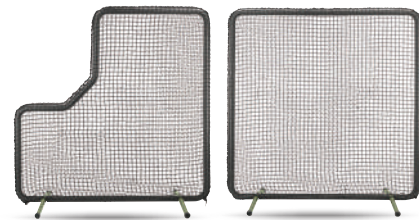

Padded L Screen Padded 1B Screen

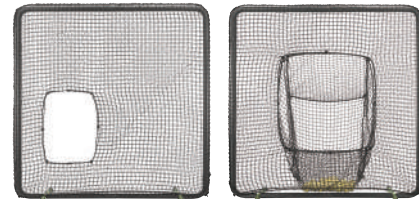

Padded SB Screen Padded BP Screen



Wheel Kit

## PADDLED PROTECTIVE SCREENS

STOCK NO.	PRODUCT	MSRP
WTAT75300LSC	Padded L Screen	\$599.99
WTAT754001BSC	Padded 1B Screen	\$599.99
WTAT75600SBSC	Padded SB Screen	\$599.99
WTAT20600BPSC	Padded BP Screen w/ Ball Sock	\$599.99
WTAT1395	Wheel Kit	\$79.99

Padding Deflects Balls and Increases Durability • Steel Tubing Under Padding • Commercial Grade Weather Resistant Netting • Compatible with Optional Wheel Kit • 2 Year Limited Warranty



L Screen 1B Screen

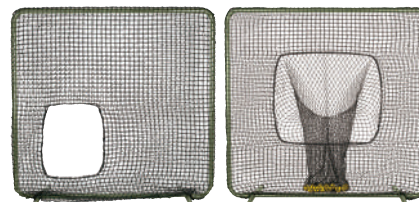

SB Screen BP Screen



Wheel Kit

## PROTECTIVE SCREENS

STOCK NO.	PRODUCT	MSRP
WTAT7532	L Screen	\$299.99
WTAT7542	1B Screen	\$299.99
WTAT7562	SB Screen	\$299.99
WTAT2061	BP Screen w/ Ball Sock	\$299.99
WTAT1395	Wheel Kit	\$79.99

Steel Tubing • Commercial Grade Weather Resistant Netting • Compatible with Optional Wheel Kit • 1 Year Limited Warranty



R Screen Portable L Screen

## LOW PROFILE PROTECTIVE SCREENS

STOCK NO.	PRODUCT	MSRP
WTAT75500	R Screen (USSSA Approved)	\$174.99
WTAT7440	Portable L Screen w/ Travel Bag	\$179.99

Steel Tubing • Weather Resistant Netting • **Not Intended for Commercial Use** • 1 Year Limited Warranty



## REPLACEMENT NETS

STOCK NO.	PRODUCT	MSRP
WTAT7533	Replacement Net—L-Screen	\$124.99
WTAT7543	Replacement Net—1st Base Screen	\$124.99
WTAT7563	Replacement Net—SB Screen	\$124.99
WTAT2062	Replacement Net—BP Screen	\$149.99
WTAT3418	Replacement Net— Portable L-Screen	\$84.99
WTAT75511	Replacement Net—R Screen	\$84.99



# TRAINING NETS



## N1™ PORTABLE PRACTICE NET

STOCK NO.	PRODUCT	MSRP
WTATN1000	N1 (Sold in retail packaging)	\$149.99

Industry leading and proprietary angled design eliminates ball rebound and minimizes ball collection time • Utilizes durable knotted nylon netting with steel and fiberglass frame • Extremely stable in outdoor elements • Sets up in less than 2 minutes • Includes premium carrying bag • Great for both hitting and pitching drills • 1 year limited warranty



## PRO PITCHER

STOCK NO.	PRODUCT	MSRP
WTATNPP00	Pro Pitcher (Sold in retail packaging)	\$149.99
WTATPP00P1	Replacement Screen (Screen Only)	\$79.99

Highly visible numbered targets • Increases pitcher's focus and location discipline • Built-in strike zone collection pocket • Heavy duty nylon screen • Steel frame with powder-coated finish • 1 year limited warranty



# ACCESSORIES & PARTS



## CADDYPOD (SIMULATES BATTED BALL HEIGHT)

STOCK NO.	PRODUCT	WEIGHT	FOOTPRINT	MSRP
WTATAMBCP	CaddyPod	25 LBS.	900 IN <sup>2</sup>	\$399.99

Simulates batted ball height • Built in wheels allow for easy transportation and storage • Included with all new R-Series baseball and softball machines • Can be used with any M-Series or R-Series machine



Adult Configuration



Youth Configuration

## TRIPOD (SIMULATES BASEBALL PITCHER RELEASE HEIGHT)

STOCK NO.	WEIGHT	FOOTPRINT	MSRP
WTATAMBTP	30 LBS.	1260 IN <sup>2</sup>	\$299.99

Simulates baseball pitcher's release point • Included with all new M-Series baseball machines • Can be configured to achieve either an adult or youth pitch height • Can be used with any M-Series or R-Series machine



## LOWPOD (SIMULATES SOFTBALL PITCHER RELEASE HEIGHT)

STOCK NO.	WEIGHT	FOOTPRINT	MSRP
WTATAMBLP	10 LBS.	340 IN <sup>2</sup>	\$199.99

Simulates softball pitcher's release point • Included with all new M-Series softball machines • Can be used with any M-Series or R-Series machine



## MACHINE COVER

STOCK NO.	MSRP
WTATAMUCR	\$69.99

Durable water-resistant nylon with drawstring cord • Helps protect machine from the elements • Fits all ATEC Training Machines



## WIRELESS REMOTE

STOCK NO.	RANGE	MSRP
WTAT0441	50'	\$69.99

Feeder remote has a 50' range • Compatible with current bucket feeder, M2 15 & 20 Ball Feeder, and Casey Pro 36 15 & 20 Ball Feeder



For Reference

## TRIPOD BUCKET HOLDER CLIP

STOCK NO.	WEIGHT	MSRP
WTATABKTHDR	1 LB.	\$14.99

Compatible with any ATEC Baseball Tripod • Attach the bucket holder easily by sliding it over two of the tripod legs, allowing the machine user to easily hang any type of ball bucket with a handle from the machine • Compatible with any bucket with a handle • Included with all new M-Series Baseball machines



BB STOCK UNIFORMS

FOR ALL MACHINE REPLACEMENT PARTS CALL: 1.800.755.5100

# BASEBALL STOCK UNIFORMS

EVOSHIELD®

**E203  
2-Button  
Jersey**

Shown With:

- WTL4964: 3-color custom screen transfer lettering
- WTL4925: 2-color Vortex screen transfer numeral on front and back

PRICE AS SHOWN  
\$60<sup>99</sup>



Fit: Relaxed  
Model Measurements:  
Ht: 6ft 1"  
Chest: 41"  
Waist: 32"  
Wearing Size Medium

Available Decoration:  
• Screen Transfer  
• Film Transfer

JERSEY FEATURES:

- 100% Polyester Pin Dot Mesh
- Relaxed fit
- Contrasting shoulder and neck inserts
- Lightweight moisture wicking fabric

MEN'S SIZES  
**S-2X** | YOUTH SIZES  
**S-L**

MEN	MSRP	YOUTH	MSRP
WTV1220	\$29 <sup>99</sup>	WTV2220	\$26 <sup>99</sup>



EVOSHIELD®

**Pro Team  
Training Tee  
2.0**

Shown With:

- WTL4954: 2-color custom screen transfer lettering
- WTL4925: 2-color NCAA® screen transfer numeral on front and back

PRICE AS SHOWN  
\$64<sup>99</sup>



Fit: Athletic  
Model Measurements:  
Ht: 6ft 1"  
Chest: 41"  
Waist: 32"  
Wearing Size Medium

Available Decoration:  
• Screen Transfer  
• Film Transfer

JERSEY FEATURES:

- 92% Polyester / 8% Spandex
- Athletic fit
- Raglan sleeves for maximum mobility and comfort
- No-chafe seams
- Open knit construction for breathability
- Can be worn as a jersey or workout shirt
- Moisture wicking

MEN'S SIZES  
**S-3X** | YOUTH SIZES  
**S-L**

MEN	MSRP	YOUTH	MSRP
WB60046	\$34 <sup>99</sup>	WB60047	\$29 <sup>99</sup>



EVOSHIELD®

**Pro Team  
Training Tee**

Shown With:

- WTL4954: 2-color custom screen transfer lettering
- WTL4921: 1-color Plain Block screen transfer numeral on front and back

PRICE AS SHOWN  
\$57<sup>99</sup>



Fit: Athletic  
Model Measurements:  
Ht: 5ft 11"  
Chest: 37"  
Waist: 31"  
Wearing Size Small

Available Decoration:  
• Screen Transfer  
• Film Transfer

JERSEY FEATURES:

- 94% Polyester / 6% Spandex
- Athletic fit
- Raglan short sleeve construction maximizes player's range of motion
- Mesh back improves air flow
- Can be worn as a jersey, workout shirt, or under a jersey
- Lightweight moisture wicking antimicrobial fabric

MEN'S SIZES  
**S-3X** | YOUTH SIZES  
**S-L**

MEN	MSRP	YOUTH	MSRP
WTV9701	\$29 <sup>99</sup>	WTV9801	\$24 <sup>99</sup>



EVOSHIELD®

**E304  
Performance  
Pullover  
Heather  
Tech Tee™**

Shown With:

- WTL4954: 2-color custom screen transfer lettering
- WTL4925: 2-color NCAA® screen transfer numeral on front and back

PRICE AS SHOWN  
\$49<sup>99</sup>



Fit: Athletic  
Model Measurements:  
Ht: 6ft 1"  
Chest: 41"  
Waist: 32"  
Wearing Size Medium

Available Decoration:  
• Screen Transfer  
• Film Transfer

JERSEY FEATURES:

- 100% Polyester Interlock
- Athletic fit
- Crew neck construction
- Can be worn as a jersey, workout shirt, or under a jersey
- Lightweight moisture wicking antimicrobial fabric

ADULT SIZES  
**S-3X** | YOUTH SIZES  
**S-L**

ADULT	MSRP	YOUTH	MSRP
WTV1108	\$19 <sup>99</sup>	WTV2108	\$18 <sup>99</sup>



EVOSHIELD®

**E306  
Performance  
Pullover  
Tech Tee™**

Shown With:

- WTL4954: 2-color Script screen transfer lettering
- WTL4925: 2-color Full Block screen transfer numeral on front and back

PRICE AS SHOWN  
\$47<sup>99</sup>



Fit: Athletic  
Model Measurements:  
Ht: 6ft 1"  
Chest: 41"  
Waist: 32"  
Wearing Size Medium

Available Decoration:  
• Screen Transfer  
• Film Transfer

JERSEY FEATURES:

- 100% Polyester Interlock
- Athletic fit, crew neck construction
- Can be worn as a jersey, workout shirt, or under a jersey
- Lightweight moisture wicking fabric

ADULT SIZES  
**S-3X** | YOUTH SIZES  
**S-L**

ADULT	MSRP	YOUTH	MSRP	
WB6003401	\$17 <sup>99</sup>	WB6003501	\$16 <sup>99</sup>	BLACK
WB6003402	\$17 <sup>99</sup>	WB6003502	\$16 <sup>99</sup>	CARDINAL
WB6003403	\$17 <sup>99</sup>	WB6003503	\$16 <sup>99</sup>	CHARCOAL
WB6003404	\$17 <sup>99</sup>	WB6003504	\$16 <sup>99</sup>	DARK GREEN
WB6003406	\$17 <sup>99</sup>	WB6003506	\$16 <sup>99</sup>	MAROON
WB6003407	\$17 <sup>99</sup>	WB6003507	\$16 <sup>99</sup>	NAVY
WB6003408	\$17 <sup>99</sup>	WB6003508	\$16 <sup>99</sup>	ORANGE
WB6003409	\$17 <sup>99</sup>	WB6003509	\$16 <sup>99</sup>	PINK
WB6003410	\$17 <sup>99</sup>	WB6003510	\$16 <sup>99</sup>	PURPLE
WB6003411	\$17 <sup>99</sup>	WB6003511	\$16 <sup>99</sup>	ROYAL
WB6003412	\$17 <sup>99</sup>	WB6003512	\$16 <sup>99</sup>	SCARLET
WB6003413	\$17 <sup>99</sup>	WB6003513	\$16 <sup>99</sup>	TEAM WHITE
WB6003415	\$17 <sup>99</sup>	WB6003515	\$16 <sup>99</sup>	TEXAS ORANGE
WB6003416	\$17 <sup>99</sup>	WB6003516	\$16 <sup>99</sup>	LIGHT GOLD*
WB6003417	\$17 <sup>99</sup>	WB6003517	\$16 <sup>99</sup>	VICTORY BLUE*

\*REVISED COLOR



## EVOSHIELD® GENERAL™

- PANT FEATURES:**
- Pro Stretch fabric
  - 100% polyester warp knit (8.3 oz.)
  - Athletic fit
  - Hemmed open bottom
  - 2 set-in back pockets
  - Double layered knees for a longer-lasting pant
  - Evoshield® elastic gripper waistband improves fit and comfort on the field
  - Moisture wicking fabric helps keep you dry and cool
- MEN'S SIZES** S-2X | **YOUTH SIZES** S-XL
- PIPING AVAILABLE \$9<sup>00</sup>



WHILE SUPPLIES LAST!



BG [BLUE GREY] | TW [TEAM WHITE]

ADULT & YOUTH: GRADUATED INSEAMS

COLOR	MEN	MSRP	YOUTH	MSRP
BG	WTV1077BG	\$59 <sup>99</sup>	WTV2077BG	\$54 <sup>99</sup>
TW	WTV1077TW	\$59 <sup>99</sup>	WTV2077TW	\$54 <sup>99</sup>

ADULT GRADUATED INSEAMS | YOUTH GRADUATED INSEAMS

SIZE	INSEAM	SIZE	INSEAM
S	31"	S	24"
M	32"	M	26"
L	33"	L	28"
XL	33"	XL	30"
2X	33"		

## EVOSHIELD® THROWBACK™

- PANT FEATURES:**
- Pro Stretch fabric
  - 100% polyester warp knit (8.3 oz.)
  - Athletic fit
  - Knicker cut
  - 2 set-in back pockets
  - Double layered knees for a longer-lasting pant
  - Evoshield® elastic gripper waistband improves fit and comfort on the field
  - Moisture wicking fabric helps keep you dry and cool
- MEN'S SIZES** S-2X | **YOUTH SIZES** S-XL
- PIPING AVAILABLE \$9<sup>00</sup>



WHILE SUPPLIES LAST!



BG [BLUE GREY] | TW [TEAM WHITE]

ADULT & YOUTH: GRADUATED INSEAMS

COLOR	MEN	MSRP	YOUTH	MSRP
BG	WTV1078BG	\$49 <sup>99</sup>	WTV2078BG	\$44 <sup>99</sup>
TW	WTV1078TW	\$49 <sup>99</sup>	WTV2078TW	\$44 <sup>99</sup>

ADULT GRADUATED INSEAMS | YOUTH GRADUATED INSEAMS

SIZE	INSEAM	SIZE	INSEAM
S	16.5"	S	12"
M	18.5"	M	14"
L	18.5"	L	16"
XL	19.5"	XL	18"
2X	19.5"		

## EVOSHIELD® SALUTE™

- PANT FEATURES:**
- 100% polyester double knit (8 oz.)
  - Athletic fit
  - Hemmed open bottom
  - 2 set-in back pockets
  - Double layered knees for a longer-lasting pant
  - Evoshield® elastic gripper waistband improves fit and comfort on the field
  - Moisture wicking fabric helps keep you dry and cool
- MEN'S SIZES** S-2X | **YOUTH SIZES** S-XL
- PIPING AVAILABLE \$9<sup>00</sup>



BG [BLUE GREY] | TW [TEAM WHITE]

ADULT & YOUTH: GRADUATED INSEAMS

COLOR	MEN	MSRP	YOUTH	MSRP
BG	WTV1076BG	\$49 <sup>99</sup>	WTV2076BG	\$44 <sup>99</sup>
TW	WTV1076TW	\$49 <sup>99</sup>	WTV2076TW	\$44 <sup>99</sup>

ADULT GRADUATED INSEAMS | YOUTH GRADUATED INSEAMS

SIZE	INSEAM	SIZE	INSEAM
S	31"	S	24"
M	32"	M	26"
L	33"	L	28"
XL	33"	XL	30"
2X	33"		

## EVOSHIELD® SALUTE™ KNICKER

- PANT FEATURES:**
- 100% polyester double knit (8 oz.)
  - Athletic fit
  - 2 set-in back pockets
  - Double layered knees for a longer-lasting pant
  - Evoshield® elastic gripper waistband improves fit and comfort on the field
  - Moisture wicking fabric helps keep you dry and cool
- MEN'S SIZES** S-2X | **YOUTH SIZES** S-XL
- PIPING AVAILABLE \$9<sup>00</sup>



01 [TEAM WHITE] | 02 [BLUE GREY]

ADULT & YOUTH: GRADUATED INSEAMS

COLOR	MEN	MSRP	YOUTH	MSRP
Team White	WB6000501	\$44 <sup>99</sup>	WB6000601	\$39 <sup>99</sup>
Blue Grey	WB6000502	\$44 <sup>99</sup>	WB6000602	\$39 <sup>99</sup>

ADULT GRADUATED INSEAMS | YOUTH GRADUATED INSEAMS

SIZE	INSEAM	SIZE	INSEAM
S	16.5"	S	12"
M	18.5"	M	14"
L	18.5"	L	16"
XL	19.5"	XL	18"
2X	19.5"		

## EVOSHIELD® SALUTE™ PINSTRIPE

- PANT FEATURES:**
- 100% polyester double knit (8 oz.)
  - Athletic fit - provides contoured, slim silhouette
  - Hemmed open bottom
  - 2 set-in back pockets
  - Double layered knees for a longer-lasting pant
  - Evoshield® elastic gripper waistband improves fit and comfort on the field
  - Moisture wicking fabric helps keep you dry and cool
- MEN'S SIZES** S-2X | **YOUTH SIZES** YS-YXL
- PIPING AVAILABLE \$9<sup>00</sup>



01 [TEAM WHITE/BLACK] | 02 [TEAM WHITE/NAVY]

ADULT & YOUTH: GRADUATED INSEAMS

COLOR	MEN	MSRP	YOUTH	MSRP
TW/BL	WB6017701	\$54 <sup>99</sup>	WB6017801	\$49 <sup>99</sup>
TW/NA	WB6017702	\$54 <sup>99</sup>	WB6017802	\$49 <sup>99</sup>

ADULT GRADUATED INSEAMS | YOUTH GRADUATED INSEAMS

SIZE	INSEAM	SIZE	INSEAM
S	31"	S	24"
M	32"	M	26"
L	33"	L	28"
XL	33"	XL	30"
2X	33"		

## EVOSHIELD® SALUTE™ PINSTRIPE KNICKER

- PANT FEATURES:**
- 100% polyester double knit (8 oz.)
  - Athletic fit - provides contoured, slim silhouette
  - Knicker cut
  - 2 set-in back pockets
  - Double layered knees for a longer-lasting pant
  - Evoshield® elastic gripper waistband improves fit and comfort on the field
  - Moisture wicking fabric helps keep you dry and cool
- MEN'S SIZES** S-2X | **YOUTH SIZES** YS-YXL
- PIPING AVAILABLE \$9<sup>00</sup>



01 [TEAM WHITE/BLACK] | 02 [TEAM WHITE/NAVY]

ADULT & YOUTH: GRADUATED INSEAMS

COLOR	MEN	MSRP	YOUTH	MSRP
TW/BL	WB6017901	\$49 <sup>99</sup>	WB6018001	\$44 <sup>99</sup>
TW/NA	WB6017902	\$49 <sup>99</sup>	WB6018002	\$44 <sup>99</sup>

ADULT GRADUATED INSEAMS | YOUTH GRADUATED INSEAMS

SIZE	INSEAM	SIZE	INSEAM
S	16.5"	S	12"
M	18.5"	M	14"
L	18.5"	L	16"
XL	19.5"	XL	18"
2X	19.5"		

**WILSON®**  
**P202 OPEN BOTTOM**

- PANT FEATURES:**
- 100% polyester double knit fabric (6 oz.)
  - Athletic fit
  - Hemmed open bottom
  - 2 set-in back pockets
  - Reinforced double layered knees
  - Double snap closure
  - Wilson® elastic gripper waistband improves fit and comfort on the field
  - Moisture wicking fabric helps keep you dry and cool
- MEN'S SIZES** S-2X | **YOUTH SIZES** YS-YXL
- PIPING AVAILABLE \$9<sup>99</sup>



ADULT: GRADUATED INSEAMS  
YOUTH: GRADUATED INSEAMS

COLOR	MEN	MSRP	YOUTH	MSRP
Team White	WB6003801	\$29 <sup>99</sup>	WB6003901	\$24 <sup>99</sup>
Blue Grey	WB6003802	\$29 <sup>99</sup>	WB6003902	\$24 <sup>99</sup>

ADULT GRADUATED INSEAMS		YOUTH GRADUATED INSEAMS	
W	WB60036	W	WB60037 WB60039
SIZE	INSEAM	SIZE	INSEAM
S	31"	S	24"
M	32"	M	26"
L	33"	L	28"
XL	33"	XL	30"
2X	33"		

**WILSON®**  
**P203K KNICKER**

- PANT FEATURES:**
- 100% polyester double knit fabric (6 oz.)
  - Athletic fit
  - 2 set-in back pockets
  - Reinforced double layered knees
  - Double snap closure
  - Wilson® elastic gripper waistband improves fit and comfort on the field
  - Moisture wicking fabric helps keep you dry and cool
- MEN'S SIZES** S-2X | **YOUTH SIZES** YS-YXL
- PIPING AVAILABLE \$9<sup>99</sup>



ADULT: GRADUATED INSEAMS  
YOUTH: GRADUATED INSEAMS

COLOR	MEN	MSRP	YOUTH	MSRP
Team White	WB6004401	\$24 <sup>99</sup>	WB6004501	\$19 <sup>99</sup>
Blue Grey	WB6004402	\$24 <sup>99</sup>	WB6004502	\$19 <sup>99</sup>
Black	WB6004403	\$24 <sup>99</sup>	WB6004503	\$19 <sup>99</sup>

ADULT GRADUATED INSEAMS		YOUTH GRADUATED INSEAMS	
W	WB60044	W	WB60045
SIZE	INSEAM	SIZE	INSEAM
S	16.5"	S	12"
M	18.5"	M	14"
L	18.5"	L	16"
XL	19.5"	XL	18"
2X	19.5"		

**WILSON®**  
**P101K PULLUP KNICKER**

- PANT FEATURES:**
- 100% polyester double knit fabric (6 oz.)
  - Athletic fit
  - 1 set-in back pocket
  - Reinforced double layered knees
  - Gathered elastic waistband
  - Moisture wicking fabric helps keep you dry and cool
- MEN'S SIZES** S-2X | **YOUTH SIZES** YS-YXL



ADULT: GRADUATED INSEAMS  
YOUTH: GRADUATED INSEAMS

COLOR	MEN	MSRP	YOUTH	MSRP
Team White	WB6004201	\$19 <sup>99</sup>	WB6004301	\$14 <sup>99</sup>
Blue Grey	WB6004202	\$19 <sup>99</sup>	WB6004302	\$14 <sup>99</sup>
Black	WB6004203	\$19 <sup>99</sup>	WB6004303	\$14 <sup>99</sup>

YOUTH GRADUATED INSEAMS	
W	WB60042
SIZE	INSEAM
S	18.5"
M	18.5"
L	18.5"
XL	18.5"
2X	19.5"

**EVOSHIELD®**  
**PRO-SRZ STRIPED GAME SOCKS**

- SOCK FEATURES:**
- 58% Nylon/28% Polyester/8% Cotton/6% Spandex
  - Variegated rib leg
  - Graduated compression for a perfect fit
  - Spot ankle and Achilles cushioning provide improved comfort
  - Deep heel pocket
  - Ergonomic sole cushioning and toe cushioning
  - Mesh ventilation help keep your feet dry and cool on the field
  - Arch support for enhanced comfort

UNISEX	MSRP
WB60105	\$13 <sup>99</sup>



**EVOSHIELD®**  
**GAME SOCKS**

- SOCK FEATURES:**
- 93% polyester/6% Spandex/1% nylon over-the-calf knee high
  - Extended Achilles cushioning
  - Variegated leg rib; accented arch support
  - Space-dyed ergonomic cushioning
  - Moisture wicking

UNISEX	MSRP
WTV4446	\$9 <sup>99</sup>



**EVOSHIELD®**  
**THROWBACK STIRRUP GAME SOCKS**

- SOCK FEATURES:**
- 93% polyester/6% Spandex/1% nylon over-the-calf knee high
  - Extended Achilles cushioning
  - Variegated leg rib; accented arch support
  - Space-dyed ergonomic cushioning
  - Moisture wicking

UNISEX	MSRP
WTV4448	\$8 <sup>99</sup>

SOCK SIZING

SOCK	SHOE SIZE		
	MEN	WOMEN	KIDS
S	—	4-6	3Y-5Y
M	6-8	6-10	5Y-7Y
L	8-12	10-13	—
XL	12-15	—	—



**WILSON®**  
**ELASTIC BELT**

- BELT FEATURES:**
- Adult 1½" wide is one-size-fits-most
  - Youth 1" wide fits waist sizes 18-32"
  - Minimum order is 6 per style, color

ADULT	MSRP	YOUTH	MSRP
WTA4442	\$7 <sup>99</sup>	WTA4444	\$6 <sup>99</sup>





# BASEBALL TEAM APPAREL



## EVOSHIELD® PRO TEAM TRAINING TEE 2.0

	ADULT: S, M, L, XL, 2X, 3X		YOUTH: YS, YM, YL	
	Article No.	MSRP	Article No.	MSRP
Black	WB6004601	\$34. <sup>99</sup>	WB6004701	\$29. <sup>99</sup>
Charcoal	WB6004602	\$34. <sup>99</sup>	WB6004702	\$29. <sup>99</sup>
Navy	WB6004603	\$34. <sup>99</sup>	WB6004703	\$29. <sup>99</sup>
Royal	WB6004604	\$34. <sup>99</sup>	WB6004704	\$29. <sup>99</sup>
Scarlet	WB6004605	\$34. <sup>99</sup>	WB6004705	\$29. <sup>99</sup>
Team White	WB6004606	\$34. <sup>99</sup>	WB6004706	\$29. <sup>99</sup>

- Athletic fit - provides contoured, slim silhouette
- Raglan sleeves for maximum mobility and comfort
- No-chafe seams
- Open knit construction for breathability
- Can be used as a workout shirt or jersey
- Moisture-wicking fabric helps keep you dry and cool

Fit: Athletic  
Model Measurements:  
Ht: 6ft 1"  
Chest: 41"  
Waist: 32"  
Wearing Size Medium

FABRIC: 92% Polyester / 8% Spandex

Decoration additional cost



## NEW EVOSHIELD® PRO TEAM LONG SLEEVE TRAINING TEE

	ADULT: S, M, L, XL, 2X, 3X	
	Article No.	MSRP
Black	WB6021601	\$39. <sup>99</sup>
Charcoal	WB6021602	\$39. <sup>99</sup>
Navy	WB6021603	\$39. <sup>99</sup>
Royal	WB6021604	\$39. <sup>99</sup>
Scarlet	WB6021605	\$39. <sup>99</sup>
Team White	WB6021606	\$39. <sup>99</sup>

- Athletic fit - provides contoured, slim silhouette
- Raglan sleeves for maximum mobility and comfort
- No-chafe seams
- Open-knit construction for breathability
- Moisture-wicking fabric helps keep you dry and cool

Fit: Athletic  
Model Measurements:  
Ht: 6ft 2"  
Chest: 37"  
Waist: 32"  
Wearing Size Medium

FABRIC: 92% Polyester / 8% Spandex

Decoration additional cost



## NEW EVOSHIELD® TRAINING TANK

	ADULT: S, M, L, XL, 2X, 3X	
	Article No.	MSRP
Black	WB6013401	\$29. <sup>99</sup>
Lagoon	WB6013402	\$29. <sup>99</sup>
Navy	WB6013403	\$29. <sup>99</sup>
Olive	WB6013404	\$29. <sup>99</sup>
Royal	WB6013405	\$29. <sup>99</sup>
Scarlet	WB6013406	\$29. <sup>99</sup>

- Athletic fit - provides contoured, slim silhouette
- Side vent
- Open-knit construction for breathability
- Moisture-wicking fabric helps keep you dry and cool

Fit: Athletic  
Model Measurements:  
Ht: 6ft 2"  
Chest: 37"  
Waist: 32"  
Wearing Size Medium

FABRIC: 92% Polyester / 8% Spandex

Decoration additional cost



### NEW EVOSHIELD® COOLING SHORT SLEEVE

	ADULT: S, M, L, XL, 2X, 3X	
	Article No.	MSRP
Black	WB6014001	\$39.99
Navy	WB6014002	\$39.99
Royal	WB6014003	\$39.99
Scarlet	WB6014004	\$39.99
Team White	WB6014005	\$39.99

- Fitted - designed to tightly hug the shape of your body, without restricting movement
- Advanced cooling fabric technology provides a lightweight, cool feel
- UPF rated 50+ for sun protection
- Ergonomic flat seaming
- Moisture-wicking fabric helps keep you dry and cool

Fit: Fitted  
Model Measurements:  
Ht: 5ft 11"  
Chest: 37"  
Waist: 31"  
Wearing Size Small

FABRIC: 88% Polyester / 12% Spandex

Decoration additional cost



### NEW EVOSHIELD® COOLING MID SLEEVE

	ADULT: S, M, L, XL, 2X, 3X	
	Article No.	MSRP
Black	WB6014401	\$44.99
Navy	WB6014402	\$44.99
Royal	WB6014403	\$44.99
Scarlet	WB6014404	\$44.99
Team White	WB6014405	\$44.99

- Fitted - designed to tightly hug the shape of your body, without restricting movement
- Advanced cooling fabric technology provides a lightweight, cool feel
- UPF rated 50+ for sun protection
- Ergonomic flat seaming
- Moisture-wicking fabric helps keep you dry and cool

Fit: Fitted  
Model Measurements:  
Ht: 5ft 11"  
Chest: 37"  
Waist: 31"  
Wearing Size Small

FABRIC: 88% Polyester / 12% Spandex

Decoration additional cost



### NEW EVOSHIELD® COOLING LONG SLEEVE

	ADULT: S, M, L, XL, 2X, 3X	
	Article No.	MSRP
Black	WB6014201	\$49.99
Navy	WB6014202	\$49.99
Royal	WB6014203	\$49.99
Scarlet	WB6014204	\$49.99
Team White	WB6014205	\$49.99

- Fitted - designed to tightly hug the shape of your body, without restricting movement
- Advanced cooling fabric technology provides a lightweight, cool feel
- UPF rated 50+ for sun protection
- Ergonomic flat seaming
- Moisture-wicking fabric helps keep you dry and cool

Fit: Fitted  
Model Measurements:  
Ht: 6ft 2"  
Chest: 37"  
Waist: 32"  
Wearing Size Medium

FABRIC: 88% Polyester / 12% Spandex

Decoration additional cost



### EVOSHIELD® PRO TEAM TRAINING TEE

	ADULT: S, M, L, XL, 2X, 3X		MSRP
WTV9701			\$29.99
WTV9801	YOUTH: S, M, L		\$24.99

- Athletic fit - provides contoured, slim silhouette
- Raglan short sleeve construction maximizes player's range of motion
- Mesh back improves air flow
- Can be worn as a jersey, workout shirt, or under a jersey
- Moisture-wicking fabric helps keep you dry and cool

Fit: Athletic  
Model Measurements:  
Ht: 5ft 11"  
Chest: 37"  
Waist: 31"  
Wearing Size Small

FABRIC: 94% Polyester / 6% Spandex

Decoration additional cost



### EVOSHIELD® PRO TEAM MID SLEEVE

	ADULT: S, M, L, XL, 2X		MSRP
WTV1005			\$34.99
WTV2005	YOUTH: S, M, L		\$29.99

- Fitted body and ¾ length sleeves
- Air-flowing mesh side inserts
- Moisture-wicking fabric helps keep you dry and cool

Fit: Fitted  
Model Measurements:  
Ht: 5ft 11"  
Chest: 37"  
Waist: 31"  
Wearing Size Medium

FABRIC: 87% Polyester / 13% Spandex

Decoration additional cost



### NEW EVOSHIELD® WINTER BALL

	ADULT: S, M, L, XL, 2X, 3X		YOUTH: YS, YM, YL	
	Article No.	MSRP	Article No.	MSRP
Black	WB6014801	\$49.99	WB6014901	\$44.99
Navy	WB6014802	\$49.99	WB6014902	\$44.99
Royal	WB6014803	\$49.99	WB6014903	\$44.99
Scarlet	WB6014804	\$49.99	WB6014904	\$44.99
Team White	WB6014805	\$49.99	WB6014905	\$44.99

- Mid weight fabric with fleece back
- Fitted - designed to tightly hug the shape of your body, without restricting movement
- Ventilated underarm panel helps keep you comfortable when working out
- Ventilated back detail

Fit: Fitted  
Model Measurements:  
Ht: 5ft 11"  
Chest: 37"  
Waist: 31"  
Wearing Size Small

FABRIC: 90% Polyester / 10% Spandex

Decoration additional cost



### EVOSHIELD® PRO TEAM HOODIE

		MSRP
WTV1089	ADULT: S, M, L, XL, 2X, 3X	\$59. <sup>99</sup>
WTV2089	YOUTH: S, M, L	\$54. <sup>99</sup>

- Relaxed fit allows for a totally unrestricted range of motion
- 3-piece hood
- Kangaroo front pocket
- Hidden zippered media pocket
- Moisture-wicking fabric

Fit: Relaxed  
Model Measurements:  
Ht: 6ft 1"  
Chest: 41"  
Waist: 32"  
Wearing Size Medium

FABRIC: 100% Polyester

Decoration additional cost



### EVOSHIELD® PRO TEAM TRAINING HOODIE

		MSRP
WTV1092	ADULT: S, M, L, XL, 2X	\$49. <sup>99</sup>
WTV2092	YOUTH: S, M, L	\$44. <sup>99</sup>

- Athletic fit - provides contoured, slim silhouette
- 4-way stretch
- Moisture-wicking fabric

Fit: Athletic  
Model Measurements:  
Ht: 6ft 1"  
Chest: 41"  
Waist: 32"  
Wearing Size Medium

FABRIC: 100% Polyester Lightweight Interlock

Decoration additional cost



### EVOSHIELD® LONG SLEEVE BP JACKET

		ADULT: S, M, L, XL, 2X, 3X
		Article No.
		MSRP
Black		WB6002201 \$79. <sup>99</sup>
Charcoal		WB6002202 \$79. <sup>99</sup>
Navy		WB6002203 \$79. <sup>99</sup>
Team White		WB6002204 \$79. <sup>99</sup>
Royal		WB6002205 \$79. <sup>99</sup>
Scarlet		WB6002206 \$79. <sup>99</sup>

- Relaxed fit allows for a totally unrestricted range of motion
- Kangaroo front pocket with zip closure
- Locking drawcord on bottom hem
- ¾ zip with reflective taping
- Rear mesh yoke
- Reflective exterior locker loop
- Breathable mesh side inserts
- Removable sleeves; jacket can be worn as long sleeve or short sleeve

Fit: Relaxed  
Model Measurements:  
Ht: 6ft 2"  
Chest: 37"  
Waist: 32"  
Wearing Size Medium

FABRIC: 94% Polyester / 6% Spandex

Decoration additional cost

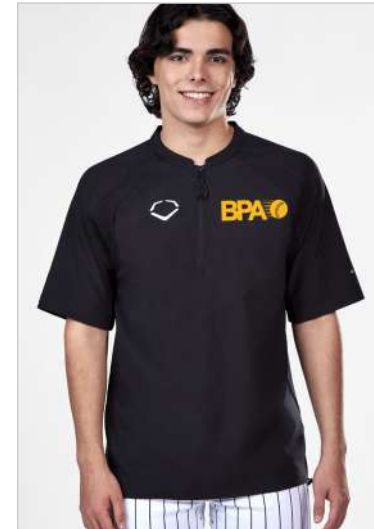

### EVOSHIELD® PRO TEAM BP JACKET

		MSRP
WTV1091	ADULT: S, M, L, XL, 2X, 3X	\$54. <sup>99</sup>
WTV2091	YOUTH: S, M, L	\$49. <sup>99</sup>

- Relaxed fit allows for a totally unrestricted range of motion
- ¾ zip neck line
- Strategic rib placement to maximize mobility
- Locking drawcord in the bottom hem to adjust fit
- Moisture wicking fabric

Fit: Relaxed  
Model Measurements:  
Ht: 5ft 11"  
Chest: 37"  
Waist: 31"  
Wearing Size Small

FABRIC: 94% Polyester / 6% Spandex

Decoration additional cost



### NEW EVOSHIELD® PRO TEAM HEATER FLEECE

		ADULT: S, M, L, XL, 2X, 3X
		Article No.
		MSRP
Black		WB6016101 \$59. <sup>99</sup>
Charcoal		WB6016102 \$59. <sup>99</sup>
Navy		WB6016103 \$59. <sup>99</sup>
Royal		WB6016104 \$59. <sup>99</sup>
Scarlet		WB6016105 \$59. <sup>99</sup>

- Relaxed fit allows for a totally unrestricted range of motion
- Concealed kangaroo pocket
- Rib cuff, collar and hem

Fit: Relaxed  
Model Measurements:  
Ht: 6ft 2"  
Chest: 37"  
Waist: 32"  
Wearing Size Medium

FABRIC: 95% Polyester / 5% Spandex

Decoration additional cost



### EVOSHIELD® PRO TEAM SHORT 2.0

	ADULT: S, M, L, XL, 2X, 3X		YOUTH: YS, YM, YL	
	Article No.	MSRP	Article No.	MSRP
Black	WB6005501	\$34. <sup>99</sup>	WB6005601	\$29. <sup>99</sup>
Charcoal	WB6005502	\$34. <sup>99</sup>	WB6005602	\$29. <sup>99</sup>
Navy	WB6005503	\$34. <sup>99</sup>	WB6005603	\$29. <sup>99</sup>
Royal	WB6005504	\$34. <sup>99</sup>	WB6005604	\$29. <sup>99</sup>
Scarlet	WB6005505	\$34. <sup>99</sup>	WB6005605	\$29. <sup>99</sup>
Light Gold	WB6005508	\$34. <sup>99</sup>	WB6005608	\$29. <sup>99</sup>
Texas Orange	WB6005512	\$34. <sup>99</sup>	WB6005612	\$29. <sup>99</sup>
Victory Blue	WB6005513	\$34. <sup>99</sup>	WB6005613	\$29. <sup>99</sup>

- Designed for player workouts and practice
- Plush Evoshield® waistband w/adjustable drawcord
- 7½" inseam
- 2 side pockets
- Side vent for breathability

Fit: Athletic  
Model Measurements:  
Ht: 6ft 1"  
Waist: 32"  
Wearing Size Medium

FABRIC: 100% Polyester

Decoration additional cost



### EVOSHIELD® PRO TEAM CLUBHOUSE FLEECE SHORT

	ADULT: S, M, L, XL, 2X, 3X	
	Article No.	MSRP
Black	WB6001701	\$44. <sup>99</sup>
Grey	WB6001702	\$44. <sup>99</sup>
Navy	WB6001703	\$44. <sup>99</sup>

- 2 front pockets and 1 rear zippered pocket
- Graduated inseams
- Rib waistband with drawcord

Fit: Athletic  
Model Measurements:  
Ht: 6ft 1"  
Waist: 32"  
Wearing Size Medium

FABRIC: 38% Cotton / 58% Polyester / 4% Spandex

Decoration additional cost

SIZE	INSEAM
S	9"
M	9"
L	9.5"
XL	9.5"
2X	10"
3X	10"



### EVOSHIELD® PRO TEAM SHORT SLEEVE HOODIE

	ADULT: S, M, L, XL, 2X, 3X		YOUTH: YS, YM, YL	
	Article No.	MSRP	Article No.	MSRP
Black	WB6001601	\$74. <sup>99</sup>	WB6004801	\$69. <sup>99</sup>
Grey	WB6001602	\$74. <sup>99</sup>	WB6004802	\$69. <sup>99</sup>
Navy	WB6001603	\$74. <sup>99</sup>	WB6004803	\$69. <sup>99</sup>

- Relaxed fit allows for a totally unrestricted range of motion
- Front zippered pocket
- Kangaroo pocket
- 3-piece hood with drawcord
- 4-way stretch

Fit: Relaxed  
Model Measurements:  
Ht: 6ft 1"  
Chest: 41"  
Waist: 32"  
Wearing Size Medium

FABRIC: 71% Cotton / 25% Polyester / 4% Spandex

Decoration additional cost



### EVOSHIELD® HYBRID LONG SLEEVE FLEECE HOODIE

	ADULT: S, M, L, XL, 2X, 3X	
	Article No.	MSRP
Black	WB6001501	\$79. <sup>99</sup>
Grey	WB6001502	\$79. <sup>99</sup>
Navy	WB6001503	\$79. <sup>99</sup>

- Relaxed fit allows for a totally unrestricted range of motion
- Water resistant 3-piece hood with drawcord
- Water resistant shoulders
- Water resistant front kangaroo pocket
- Front zippered pocket
- 4-way stretch

Fit: Relaxed  
Model Measurements:  
Ht: 6ft 1"  
Chest: 41"  
Waist: 32"  
Wearing Size Medium

FABRIC: 71% Cotton / 25% Polyester / 4% Spandex

Decoration additional cost



### EVOSHIELD® SLEEVELESS PREGAME HOODIE

	ADULT: S, M, L, XL, 2X, 3X	
	Article No.	MSRP
Black	WB6004901	\$69. <sup>99</sup>
Grey	WB6004902	\$69. <sup>99</sup>
Navy	WB6004903	\$69. <sup>99</sup>

- Relaxed fit allows for a totally unrestricted range of motion
- Zippered ¼ zip neck
- 3-piece hood with drawcord
- Kangaroo front pocket
- 4-way stretch

Fit: Relaxed  
Model Measurements:  
Ht: 6ft 1"  
Chest: 41"  
Waist: 32"  
Wearing Size Medium

FABRIC: 71% Cotton / 25% Polyester / 4% Spandex

Decoration additional cost



### NEW EVOSHIELD® LIGHTWEIGHT SLEEVELESS HOODIE

	ADULT: S, M, L, XL, 2X, 3X	
	Article No.	MSRP
Black	WB6007201	\$44. <sup>99</sup>
Team White	WB6007202	\$44. <sup>99</sup>
Navy	WB6007203	\$44. <sup>99</sup>

- Athletic fit - provides contoured, slim silhouette
- Three-piece hood
- Side vent
- Moisture-wicking fabric helps keep you dry and cool

Fit: Athletic  
Model Measurements:  
Ht: 6ft 1"  
Chest: 41"  
Waist: 32"  
Wearing Size Medium

FABRIC: 100% Polyester

Decoration additional cost



### NEW EVOSHIELD® LIGHTWEIGHT SHORT SLEEVE HOODIE

	ADULT: S, M, L, XL, 2X, 3X		YOUTH: YS, YM, YL	
	Article No.	MSRP	Article No.	MSRP
Black	WB6013801	\$39. <sup>99</sup>	WB6013901	\$34. <sup>99</sup>
Navy	WB6013802	\$39. <sup>99</sup>	WB6013902	\$34. <sup>99</sup>
Royal	WB6013803	\$39. <sup>99</sup>	WB6013903	\$34. <sup>99</sup>
Scarlet	WB6013804	\$39. <sup>99</sup>	WB6013904	\$34. <sup>99</sup>

- Athletic fit - provides contoured, slim silhouette
- Kangaroo pocket
- Side vent
- Three-piece hood

Fit: Athletic  
Model Measurements:  
Ht: 5'11"  
Chest: 37"  
Waist: 31"  
Wearing Size Medium

FABRIC: 60% Cotton / 40% Recycled Polyester

Decoration additional cost



### NEW EVOSHIELD® SIDELINE HOODIE

	ADULT: S, M, L, XL, 2X, 3X		YOUTH: YS, YM, YL	
	Article No.	MSRP	Article No.	MSRP
Black	WB6018501	\$49. <sup>99</sup>	WB6018601	\$44. <sup>99</sup>
Heather Grey	WB6018502	\$49. <sup>99</sup>	WB6018602	\$44. <sup>99</sup>
Navy	WB6018503	\$49. <sup>99</sup>	WB6018603	\$44. <sup>99</sup>
Team White	WB6018504	\$49. <sup>99</sup>	WB6018604	\$44. <sup>99</sup>

- Relaxed fit allows for a totally unrestricted range of motion
- Three-piece hood
- Kangaroo front pocket
- Midweight fabric makes this a perfect year-round piece

FABRIC: 60% Cotton / 40% Polyester

Coming Late 2021

Decoration additional cost



### EVOSHIELD® FLAGSHIP POLO

	ADULT: S, M, L, XL, 2X, 3X	
	Article No.	MSRP
Charcoal	WB6002001	\$54. <sup>99</sup>
Navy	WB6002002	\$54. <sup>99</sup>
Light Grey	WB6002003	\$54. <sup>99</sup>
Team White	WB6002004	\$54. <sup>99</sup>

- Relaxed fit allows for a totally unrestricted range of motion
- Engineered stripe pattern
- Raglan sleeves
- 3-button front
- Side vent

Fit: Relaxed  
Model Measurements:  
Ht: 6ft 2"  
Chest: 37"  
Waist: 32"  
Wearing Size Medium

FABRIC: 100% Polyester

Decoration additional cost



### EVOSHIELD® GRANDSTAND POLO

	ADULT: S, M, L, XL, 2X, 3X	
	Article No.	MSRP
Charcoal	WB6002101	\$59. <sup>99</sup>
Navy	WB6002102	\$59. <sup>99</sup>
Team White	WB6002103	\$59. <sup>99</sup>
Black	WB6002104	\$59. <sup>99</sup>

- Athletic fit - provides contoured, slim silhouette
- Rib collar and cuff
- Raglan sleeves
- 3-button front
- Side vent

Fit: Athletic  
Model Measurements:  
Ht: 6ft 2"  
Chest: 37"  
Waist: 32"  
Wearing Size Medium

FABRIC: 55% Cotton / 39% Polyester / 6% Spandex

Decoration additional cost



### NEW EVOSHIELD® LIGHTWEIGHT ¼ ZIP

	ADULT: S, M, L, XL, 2X, 3X	
	Article No.	MSRP
Black	WB6007101	\$49. <sup>99</sup>
Charcoal	WB6007102	\$49. <sup>99</sup>
Navy	WB6007103	\$49. <sup>99</sup>
Royal	WB6007104	\$49. <sup>99</sup>
Scarlet	WB6007105	\$49. <sup>99</sup>

- Athletic fit - provides contoured, slim silhouette
- Mock neck with ¼ zip

Fit: Athletic  
Model Measurements:  
Ht: 6ft 2"  
Chest: 37"  
Waist: 32"  
Wearing Size Medium

FABRIC: 100% Polyester

Decoration additional cost



### EVOSHIELD® PST GME SHORT

	ADULT: 30-48	
	Article No.	MSRP
Black	WB6002301	\$59. <sup>99</sup>
Stone	WB6002302	\$59. <sup>99</sup>
Charcoal	WB6002303	\$59. <sup>99</sup>

- Athletic fit - provides contoured, slim silhouette
- 2 front pockets
- 2 rear pockets
- Additional side zippered pocket to stash essentials
- Zippered fly front
- Elastic waistband with silicone gripper
- 8.5" Inseam

Fit: Athletic  
Model Measurements:  
Ht: 6ft 2"  
Waist: 32"  
Wearing Size 32

FABRIC: 92% Polyester / 8% Spandex

Decoration additional cost



### NEW EVOSHIELD® PST GME PANT

	ADULT: 30-40		
	Inseam	Article No.	MSRP
Black	30"	WB6019601	\$74. <sup>99</sup>
Black	32"	WB6019701	\$74. <sup>99</sup>
Black	34"	WB6019801	\$74. <sup>99</sup>
Charcoal	30"	WB6019603	\$74. <sup>99</sup>
Charcoal	32"	WB6019703	\$74. <sup>99</sup>
Charcoal	34"	WB6019803	\$74. <sup>99</sup>

- Athletic fit - provides contoured, slim silhouette
- Two front pockets
- Rear back zippered pocket
- Additional side pocket to hide away valuables
- Zippered fly front
- Inner elastic waistband with silicone gripper

Fit: Athletic  
Model Measurements:  
Ht: 6ft 2"  
Waist: 31"  
Wearing Size 30-34

FABRIC: 92% Polyester / 8% Spandex



### EVOSHIELD® TERRY SWEATSHIRT

	ADULT: S, M, L, XL, 2X, 3X		YOUTH: YS, YM, YL	
	Article No.	MSRP	Article No.	MSRP
Black	WB6005001	\$59. <sup>99</sup>	WB6005101	\$54. <sup>99</sup>
Heather Grey	WB6005002	\$59. <sup>99</sup>	WB6005102	\$54. <sup>99</sup>
Navy	WB6005003	\$59. <sup>99</sup>	WB6005103	\$54. <sup>99</sup>
Royal	WB6005004	\$59. <sup>99</sup>	WB6005104	\$54. <sup>99</sup>
Scarlet	WB6005005	\$59. <sup>99</sup>	WB6005105	\$54. <sup>99</sup>

- Athletic fit - provides contoured, slim silhouette
- Rib trim at the cuffs, hem and neckline
- Set-in sleeves

Fit: Athletic  
Model Measurements:  
Ht: 6ft 1"  
Chest: 41"  
Waist: 32"  
Wearing Size Medium

FABRIC: 95% Cotton / 5% Spandex French Terry

Decoration additional cost



### EVOSHIELD® TERRY SHORT SLEEVE SWEATSHIRT

	ADULT: S, M, L, XL, 2X, 3X	
	Article No.	MSRP
Black	WB6005201	\$54. <sup>99</sup>
Heather Grey	WB6005202	\$54. <sup>99</sup>
Navy	WB6005203	\$54. <sup>99</sup>
Royal	WB6005204	\$54. <sup>99</sup>
Scarlet	WB6005205	\$54. <sup>99</sup>

- Athletic fit - provides contoured, slim silhouette
- Rib trim at the hem and neckline
- Raglan sleeves
- Substantial fabric delivers superior softness

Fit: Athletic  
Model Measurements:  
Ht: 6ft 2"  
Chest: 37"  
Waist: 32"  
Wearing Size Medium

FABRIC: 95% Cotton / 5% Spandex French Terry

Decoration additional cost



### EVOSHIELD® HEATHER MID SLEEVE

	ADULT: S, M, L, XL, 2X, 3X		YOUTH: S, M, L	
	Article No.	MSRP	Article No.	MSRP
Charcoal/Black	WB6000801	\$24.99	WB6000901	\$19.99
Charcoal/Navy	WB6000802	\$24.99	WB6000902	\$19.99
Charcoal/Scarlet	WB6000803	\$24.99	WB6000903	\$19.99
Charcoal/Royal	WB6000804	\$24.99	WB6000904	\$19.99
Charcoal/Maroon	WB6000805	\$24.99	WB6000905	\$19.99
Charcoal/Purple	WB6000806	\$24.99	WB6000906	\$19.99
Charcoal/Dark Green	WB6000807	\$24.99	WB6000907	\$19.99

- Athletic fit - provides contoured, slim silhouette
- Heathered fabric
- Raglan % length sleeves
- Contrast body
- Rib crew neck

Fit: Athletic  
Model Measurements:  
Ht: 6ft 1"  
Chest: 41"  
Waist: 32"  
Wearing Size Medium

FABRIC: 52% Polyester / 48% Cotton Heathered Fabric

Decoration additional cost



### EVOSHIELD® HEATHER LONG SLEEVE TEE

	ADULT: S, M, L, XL, 2X, 3X		MSRP
	YOUTH: S, M, L		
WTV1001			\$24.99
WTV2001			\$19.99

- Athletic fit - provides contoured, slim silhouette
- Heathered fabric
- Rib crew neck

Fit: Athletic  
Model Measurements:  
Ht: 6ft 1"  
Chest: 41"  
Waist: 32"  
Wearing Size Medium

FABRIC: 52% Polyester / 48% Cotton Heathered Fabric

Decoration additional cost



### EVOSHIELD® HEATHER SHORT SLEEVE TEE

	ADULT: S, M, L, XL, 2X, 3X		MSRP
	YOUTH: S, M, L		
WTV1002			\$19.99
WTV2002			\$14.99

- Athletic fit - provides contoured, slim silhouette
- Heathered fabric
- Rib crew neck

Fit: Athletic  
Model Measurements:  
Ht: 5ft 11"  
Wearing Size Medium

FABRIC: 52% Polyester / 48% Cotton Heathered Fabric

Decoration additional cost



### NEW EVOSHIELD® POP COLOR TERRY HOODIE

	ADULT: S, M, L, XL, 2X, 3X	
	Article No.	MSRP
Black [Neon Yellow Pop Color]	WB6006801	\$59.99
Heather Grey [Teal Pop Color]	WB6006802	\$59.99
Navy [Tangerine Pop Color]	WB6006803	\$59.99

- Athletic fit - provides contoured, slim silhouette
- Rib cuff and hem
- Front kangaroo pocket
- Three-piece hood
- Pop color drawcord and embroidered logo
- Midweight fabric makes this a perfect year-round piece

Fit: Athletic  
Model Measurements:  
Ht: 6ft 2"  
Chest: 37"  
Waist: 32"  
Wearing Size Medium

FABRIC: 95% Cotton / 5% Spandex French Terry

Decoration additional cost



### NEW EVOSHIELD® POP COLOR TERRY JOGGER

	ADULT: S, M, L, XL, 2X, 3X	
	Article No.	MSRP
Black [Neon Yellow Pop Color]	WB6006901	\$59.99
Heather Grey [Teal Pop Color]	WB6006902	\$59.99
Navy [Tangerine Pop Color]	WB6006903	\$59.99

- Athletic fit - provides contoured, slim silhouette
- Rear rib cuff with pop color detail
- Pop color drawcord and embroidered logo
- Two front pockets
- Rear pocket with zippered closure

Fit: Athletic  
Model Measurements:  
Ht: 6ft 2"  
Waist: 32"  
Inseam: 33.5"  
Wearing Size Medium

FABRIC: 95% Cotton / 5% Spandex French Terry

Decoration additional cost



### NEW EVOSHIELD® HYBRID PULLOVER

	ADULT: S, M, L, XL, 2X, 3X	
	Article No.	MSRP
Black	WB6015901	\$69. <sup>99</sup>
Navy	WB6015902	\$69. <sup>99</sup>
Olive	WB6015903	\$69. <sup>99</sup>
Pebble	WB6015904	\$69. <sup>99</sup>

- Athletic fit - provides contoured, slim silhouette
- Kangaroo front pocket
- Mesh cutout on back with panel covering
- Reflective taping
- Drawcord at hem

FABRIC: 38% Cotton / 58% Polyester / 4% Spandex and 88% Nylon / 12% Spandex Woven Coming Late 2021

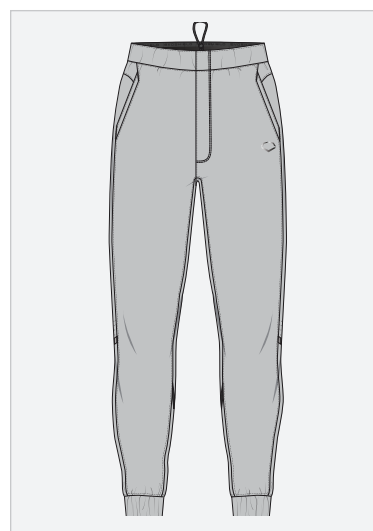

### NEW EVOSHIELD® WOVEN JOGGER

	ADULT: S, M, L, XL, 2X, 3X	
	Article No.	MSRP
Black	WB6015701	\$69. <sup>99</sup>
Navy	WB6015702	\$69. <sup>99</sup>
Olive	WB6015703	\$69. <sup>99</sup>
Pebble	WB6015704	\$69. <sup>99</sup>

- Athletic fit - provides contoured, slim silhouette
- Two front zippered pockets
- One rear functional zippered pocket and one faux pocket
- Perforation at back of knee
- Reflective taping
- Internal waistband

FABRIC: 88% Nylon / 12% Spandex Woven Coming Late 2021



### NEW EVOSHIELD® BOMBER JACKET

	ADULT: S, M, L, XL, 2X, 3X	
	Article No.	MSRP
Black	WB6007001	\$99. <sup>99</sup>
Charcoal	WB6007002	\$99. <sup>99</sup>
Navy	WB6007003	\$99. <sup>99</sup>

- Athletic fit - provides contoured, slim silhouette
- Two side pockets with snap closure
- Rib cuff, collar and bottom band
- Quilted interior lining

Fit: Athletic  
Model Measurements:  
Ht: 6ft 2"  
Chest: 37"  
Waist: 32"  
Wearing Size Medium

FABRIC: 100% Polyester

Decoration additional cost



### EVOSHIELD® KICK BACK HOODIE

		MSRP
WTV1093HG	ADULT: S, M, L, XL, 2X, 3X	\$64. <sup>99</sup>
WTV2093HG	YOUTH: S, M, L	\$59. <sup>99</sup>

- Relaxed fit allows for a totally unrestricted range of motion
- 3-piece hood
- Kangaroo front pocket

Fit: Relaxed  
Model Measurements:  
Ht: 6ft 1"  
Chest: 41"  
Waist: 32"  
Wearing Size Medium

FABRIC: 52% Cotton / 48% Polyester French Terry

Decoration additional cost



### NEW EVOSHIELD® SEAMLESS TRAINING TEE

	ADULT: S, M, L, XL, 2X	
	Article No.	MSRP
Black	WB6013601	\$54. <sup>99</sup>
Lagoon	WB6013602	\$54. <sup>99</sup>
Navy	WB6013603	\$54. <sup>99</sup>
Pebble	WB6013604	\$54. <sup>99</sup>

- Athletic fit - provides contoured, slim silhouette
- Engineered mesh ventilation
- Seamless construction

Fit: Athletic  
Model Measurements:  
Ht: 6ft 2"  
Chest: 37"  
Waist: 32"  
Wearing Size Medium

FABRIC: 65% Nylon / 35% Polyester



### NEW EVOSHIELD® FULL ZIP HOODIE

	ADULT: S, M, L, XL, 2X, 3X	
	Article No.	MSRP
Black	WB6015401	\$74. <sup>99</sup>
Navy	WB6015402	\$74. <sup>99</sup>
Olive	WB6015403	\$74. <sup>99</sup>
Pebble	WB6015404	\$74. <sup>99</sup>

- Athletic fit - provides contoured, slim silhouette
- Two front zippered pockets
- Rib cuff and hem
- Three-piece lined hood
- Midweight fabric makes this a perfect year-round piece

FABRIC: 38% Cotton / 58% Polyester / 4% Spandex

Decoration additional cost



### NEW EVOSHIELD® RECOVERY DNA 21 COMPRESSION TIGHTS

	ADULT: S, M, L, XL, 2X	
	Article No.	MSRP
Black	WB6005701	\$139. <sup>99</sup>

- Strategic body-mapped compression for improved muscle recovery, intended to help shorten recovery time
- Graduated compression
- Four-way stretch fabric delivers enhanced comfort and function
- Encased drawcord
- Seamless construction
- Designed for post-game wear
- Antimicrobial protection

Fit: Fitted Compression  
Model Measurements:  
Ht: 6ft 2"  
Waist: 32"  
Inseam: 33.5"  
Wearing Size Small

FABRIC: 70% Nylon / 30% Spandex



### NEW EVOSHIELD® RECOVERY DNA 21 ARM SLEEVES

	ADULT: S/M, M/L, L/XL	
	Article No.	MSRP
Black	WB6005801	\$34. <sup>99</sup>

- Strategic body-mapped compression for improved muscle recovery, intended to help shorten recovery time
- Graduated compression
- Four-way stretch fabric delivers enhanced comfort and function
- Seamless construction
- Designed for post-game wear
- Antimicrobial protection

Fit: Fitted Compression  
Model Measurements:  
Ht: 6ft 1"  
Wearing Size M/L

FABRIC: 70% Nylon / 30% Spandex



### EVOSHIELD® SOLID ARM SLEEVE

	ADULT: SM/LXL		YOUTH: YH	
	Article No.	MSRP	Article No.	MSRP
Black	WB6001201	\$19. <sup>99</sup>	WB6001301	\$19. <sup>99</sup>
Charcoal	WB6001202	\$19. <sup>99</sup>	WB6001302	\$19. <sup>99</sup>
Navy	WB6001203	\$19. <sup>99</sup>	WB6001303	\$19. <sup>99</sup>
Royal	WB6001204	\$19. <sup>99</sup>	WB6001304	\$19. <sup>99</sup>
Scarlet	WB6001205	\$19. <sup>99</sup>	WB6001305	\$19. <sup>99</sup>
Team White	WB6001206	\$19. <sup>99</sup>	WB6001306	\$19. <sup>99</sup>

- Lightweight fabric with moisture control
- Metallic logo

Model Measurements:  
Ht: 6ft 1"  
Wearing Size LXL

FABRIC: 80% Polyester / 20% Elastane



### NEW EVOSHIELD® ¾ SLIDING TIGHTS

	ADULT: S, M, L, XL, 2X		YOUTH: YS, YM, YL	
	Article No.	MSRP	Article No.	MSRP
Black	WB6006301	\$59.99	WB6006401	\$54.99

- ¾ length design
- Fitted - designed to tightly hug the shape of your body, without restricting movement
- EVA Knee Pad protection for improved durability
- Foam padding strategically placed to provide durability during impact of sliding
- Flat seams reduce chafing
- Mesh gusset provides ventilation
- Four-way stretch fabric delivers enhanced comfort and function
- Wide elastic waistband
- Moisture-wicking design helps keep you dry and cool

Fit: Fitted  
Model Measurements:  
Ht: 6ft 1"  
Waist: 32"  
Inseam: 32"  
Wearing Size Medium

FABRIC: 84% Nylon / 16% Spandex



### EVOSHIELD® PRO TEAM TRAINING TIGHTS

		MSRP
WTV1071	ADULT: S, M, L, XL, 2X	\$29.99

- Full length
- Flat seams to reduce chafing
- Mesh gusset and inner leg mesh panel provide ventilation
- Four way stretch
- Moisture wicking fabric

Fit: Fitted  
Model Measurements:  
Ht: 6ft 1"  
Waist: 32"  
Inseam: 32"  
Wearing Size Medium

FABRIC: 93% Polyester / 7% Spandex

WHILE SUPPLIES LAST!

WILSON TEAM SHOP  
WILSON TEAM SHOP  
WILSON TEAM SHOP  
WILSON TEAM SHOP

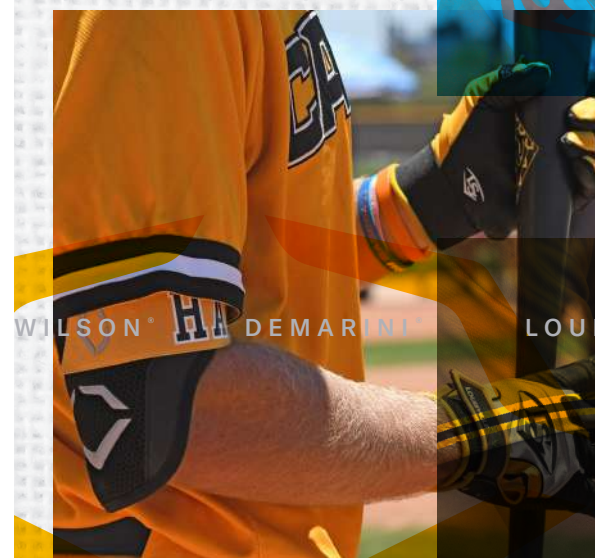

## YOUR TEAM. YOUR IDENTITY.

Create your online Team Shop stocked with customized uniforms and apparel and the top products from Wilson®, DeMarini®, Louisville Slugger®, EvoShield® and ATEC®

[WILSONTEAMSHOP.COM](http://WILSONTEAMSHOP.COM)



# STOCK BASEBALL PANTS WITH PIPING SHIPPED IN 72 HOURS

- Minimum order of 6 pieces, maximum order of 25 pieces per style and color
- Orders must be called into Sparta, TN customer service center at 800-468-8647 by 1:00 p.m. CT to qualify
- Program not available during factory closings
- Program turn based on product availability
- Program will be applied to one order per customer, per time
- Available on all Stock Baseball Pants except Salute Pinstripe, Salute Pinstripe Knicker, and P101K
- Available on all Stock Fastpitch Pants

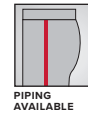

PIPING

## MEN & YOUTH SIZES

All measurements are in inches

### MEN'S TOPS & STOCK PANTS

SIZE	S	M	L	XL	2XL	3XL
CHEST	35-37	38-40	41-43	44-46	47-49	50-52
WAIST	28-30	32-34	36-38	40-42	44-46	48-50
SEAT	34-36	37-39	40-42	43-45	46-48	49-51

### YOUTH TOPS & PANTS

SIZE	XS (6)	S (7-8)	M (10-12)	L (14-16)	XL (18-20)	2XL (22)
CHEST	-	25-27	28-30	31-33	34-36	-
WAIST	22	23-24	25-27	28-30	31-33	34
SEAT	25	26-28	29-31	32-34	35-37	38

## WOMEN & GIRLS' SIZES

All measurements are in inches

### WOMEN'S TOPS & STOCK PANTS

SIZE	XS (0-2)	S (4-6)	M (8-10)	L (12-14)	XL (16-18)	2XL (20)	3XL (22)
BUST	32-33	34-35	36-38	39-41	42-44	45-46	47-49
WAIST	24-25	26-27	28-30	31-33	34-36	37-39	-
HIP	35-36	37-38	39-41	42-44	45-47	48-49	50-52

### GIRLS' TOPS & PANTS

SIZE	XS (6)	S (7-8)	M (10-12)	L (14-16)	XL (18)
BUST	-	26-28	29-31	32-34	-
WAIST	22	23-24	25-27	28-30	31-32
HIP	26	27-29	30-33	34-37	38-39



FP STOCK UNIFORMS

# FASTPITCH STOCK UNIFORMS

**EVOSHIELD®**  
**E601**  
**2-Button**  
**Placket**  
**Pullover**

Shown With:

- WTL4954: 2-color custom screen transfer lettering
- WTL4925: 2-color NCAA screen transfer numerals on front and back

PRICE AS SHOWN  
**\$57<sup>99</sup>**



Fit: Relaxed  
Model Measurements:  
Ht: 5ft 9.5"  
Chest: 36"  
Waist: 30"  
Hips: 41"  
Wearing Size Medium

Available Decoration:  
• Screen Transfer  
• Film Transfer

- JERSEY FEATURES:**
- 100% Polyester Double Bar Mesh
  - Relaxed fit
  - 2-color contrast breathable shoulder inserts
  - Lightweight moisture-wicking antimicrobial fabric

WOMEN'S SIZES  
**XS-2X** | GIRLS' SIZES  
**S-L**

WOMEN	MSRP	GIRLS	MSRP
WTV4610	\$27 <sup>99</sup>	WTV5610	\$25 <sup>99</sup>



**EVOSHIELD®**  
**FX™**  
**Training Tee**

Shown With:

- WTL4954: 2-color custom screen transfer lettering
- WTL4925: 2-color NCAA® screen transfer numeral on front and back

PRICE AS SHOWN  
**\$59<sup>99</sup>**



Fit: Athletic  
Model:  
Ht: 5ft 9"  
Wearing Size Medium

Available Decoration:  
• Screen Transfer  
• Film Transfer

- JERSEY FEATURES:**
- 100% Polyester
  - Athletic fit
  - Performance stretch
  - Can be worn as a jersey, workout shirt or under a jersey

WOMEN'S SIZES  
**XS-2X**

WOMEN	MSRP
WTV9901	\$29 <sup>99</sup>



**EVOSHIELD®**  
**E810**  
**V-Neck**  
**Pullover**  
**Jersey**

Shown With:

- WTL4964: 3-color custom screen transfer lettering
- WTL4921: 1-color NCAA screen transfer numeral on front
- WTL4921: 1-color NCAA screen transfer numeral on back

PRICE AS SHOWN  
**\$56<sup>99</sup>**



Fit: Relaxed  
Model Measurements:  
Ht: 5ft 8"  
Wearing Size Small

Available Decoration:  
• Screen Transfer  
• Film Transfer

- JERSEY FEATURES:**
- 100% Polyester Pin Dot Mesh
  - Relaxed fit
  - Contrasting shoulder and sleeve inserts
  - Lightweight moisture wicking fabric

WOMEN'S SIZES  
**XS-2X** | GIRLS' SIZES  
**S-L**

WOMEN	MSRP	GIRLS	MSRP
WTV4620	\$27 <sup>99</sup>	WTV5620	\$25 <sup>99</sup>



**DEMARINI®**  
**T600**  
**2-Button**  
**Placket**  
**Pullover**

Shown With:

- WTL4954: 2-color Fancy Block screen transfer lettering
- WTL4925: 2-color Fancy Block screen transfer numerals on front
- WTL4925: 2-color Fancy Block screen transfer numerals on back

PRICE AS SHOWN  
**\$56<sup>99</sup>**



Fit: Relaxed  
Model Measurements:  
Ht: 5ft 8"  
Wearing Size Small

Available Decoration:  
• Screen Transfer  
• Film Transfer

- JERSEY FEATURES:**
- 100% Polyester Pin Dot
  - Relaxed fit
  - White piping outlines neck
  - Breathable white side inserts
  - Lightweight moisture wicking antimicrobial fabric

WOMEN'S SIZES  
**XS-2X** | GIRLS' SIZES  
**S-L**

WOMEN	MSRP	GIRLS	MSRP
WTD4500	\$26 <sup>99</sup>	WTD5500	\$24 <sup>99</sup>



## EVOSHIELD® FX™ GAME LOW RISE

- PANT FEATURES:**
- 87% Polyester/13% Spandex (8 oz.)
  - Fabric has soft hand with performance stretch
  - Low-rise athletic fit with elastic bottom
  - Contoured leg and double knees
  - 2 set-in back pockets
  - Logo elastic gripper waistband
  - Moisture wicking fabric helps keep you dry and cool
- WOMEN'S SIZES XS-2X** | **GIRLS' SIZES S-XL**
- PIPING AVAILABLE \$9.99



WOMEN & GIRLS: GRADUATED INSEAMS



COLORS	WOMEN	MSRP	GIRLS	MSRP
Black	WB6002801	\$49.99	WB6002901	\$44.99
Blue Grey	WB6002802	\$49.99	WB6002902	\$44.99
Charcoal*	WB6002808	\$49.99	WB6002908	\$44.99
Navy	WB6002804	\$49.99	WB6002904	\$44.99
Royal	WB6002805	\$49.99	WB6002905	\$44.99
Scarlet	WB6002806	\$49.99	WB6002906	\$44.99
Team White	WB6002807	\$49.99	WB6002907	\$44.99

WOMEN'S GRADUATED INSEAMS: WB60028		GIRLS GRADUATED INSEAMS: WB60029		REVISED COLOR
SIZE	INSEAM	SIZE	INSEAM	
XS	18.5"	S	13"	
S	18.5"	M	15"	
M	19"	L	17"	
L	19"	XL	17"	
XL	19.5"			
2XL	19.5"			

## EVOSHIELD® STANDOUT™ HIGH RISE

- PANT FEATURES:**
- 100% Polyester Double Knit (8.5 oz.)
  - Pro style high-rise fitted body with fly front and elastic bottom
  - Reinforced double layered knees
  - 2 set-in back pockets
  - Wordmark gripper elastic waistband with drawcord
  - Pro tunnel loops
  - Moisture wicking fabric helps keep you dry and cool
- WOMEN'S SIZES XS-3X** | **GIRLS' SIZES S-XL**
- PIPING AVAILABLE \$9.99



WOMEN: 20" INSEAM  
GIRLS: GRADUATED INSEAMS



COLORS	WOMEN	MSRP	GIRLS	MSRP
Black	WB6008301	\$49.99	WB6008401	\$44.99
Blue Grey	WB6008302	\$49.99	WB6008402	\$44.99
Charcoal*	WB6008303	\$49.99	WB6008403	\$44.99
Navy	WB6008304	\$49.99	WB6008404	\$44.99
Royal*	WB6008308	\$49.99	WB6008408	\$44.99
Scarlet	WB6008306	\$49.99	WB6008406	\$44.99
Team White	WB6008307	\$49.99	WB6008407	\$44.99

GIRLS GRADUATED INSEAMS: WB60084		REVISED COLOR
SIZE	INSEAM	
GS	14"	
GM	16"	
GL	18"	
GXL	19"	

## DEMARINI® FIERCE™ MID RISE

- PANT FEATURES:**
- 100% Polyester Double Knit (8 oz.)
  - Mid-rise athletic fit with elastic bottom
  - Double layered knees
  - 2-set in back pockets
  - Wordmark gripper elastic waistband with drawcord
  - Moisture wicking fabric helps keep you dry and cool
- WOMEN'S SIZES S-2X** | **GIRLS' SIZES XS-L**
- PIPING AVAILABLE \$9.99



WOMEN: 22" INSEAM  
GIRLS: GRADUATED INSEAMS



COLORS	WOMEN	MSRP	GIRLS	MSRP
Black	WTD3040BL	\$39.99	WTD4040BL	\$34.99
Blue Grey	WTD3040BG	\$39.99	WTD4040BG	\$34.99
Charcoal	WTD3040CH	\$39.99	WTD4040CH	\$34.99
Navy	WTD3040NA	\$39.99	WTD4040NA	\$34.99
Royal*	WTD304001	\$39.99	WTD404001	\$34.99
Scarlet	WTD3040SC	\$39.99	WTD4040SC	\$34.99
Team White	WTD3040TW	\$39.99	WTD4040TW	\$34.99

GIRLS GRADUATED INSEAMS: WTD4040		REVISED COLOR
SIZE	INSEAM	
XS	12"	
S	14"	
M	16"	
L	18"	

## EVOSHIELD® PRO-SRZ STRIPED GAME SOCKS

- SOCK FEATURES:**
- 58% Nylon/28% Polyester/8% Cotton/6% Spandex
  - Variegated rib leg
  - Graduated compression for a perfect fit
  - Spot ankle and Achilles cushioning provide improved comfort
  - Deep heel pocket
  - Ergonomic sole cushioning and toe cushioning
  - Mesh ventilation help keep your feet dry and cool on the field
  - Arch support for enhanced comfort

UNISEX	MSRP
WB60105	\$13.99

## EVOSHIELD® GAME SOCKS

- SOCK FEATURES:**
- 93% polyester/6% Spandex/1% nylon over-the-calf knee high
  - Extended Achilles cushioning
  - Variegated leg rib; accented arch support
  - Space-dyed ergonomic cushioning
  - Moisture wicking

UNISEX	MSRP
WTV4446	\$9.99

## EVOSHIELD® THROWBACK STIRRUP GAME SOCKS

- SOCK FEATURES:**
- 93% polyester/6% Spandex/1% nylon over-the-calf knee high
  - Extended Achilles cushioning
  - Variegated leg rib; accented arch support
  - Space-dyed ergonomic cushioning
  - Moisture wicking

UNISEX	MSRP
WTV4448	\$8.99

### SOCK SIZING

SOCK	SHOE SIZE		
	MEN	WOMEN	KIDS
S	—	4-6	3Y-5Y
M	6-8	6-10	5Y-7Y
L	8-12	10-13	—
XL	12-15	—	—

NEW



UNISEX SIZES S-XL



UNISEX SIZES S-XL



UNISEX SIZES S-XL



## WILSON® ELASTIC BELT

- BELT FEATURES:**
- Adult 1½" wide is one-size-fits-most
  - Youth 1" wide fits waist sizes 18-32"
  - Minimum order is 6 per style, color

ADULT	MSRP	YOUTH	MSRP
WTA4442	\$7.99	WTA4444	\$6.99



ADULT SIZE 1½" | YOUTH SIZE 1"





### EVOSHIELD® FX™ SHORT SLEEVE TRAINING TEE

		MSRP
WTV9901	WOMEN: XS, S, M, L, XL, 2X	\$29.99
<ul style="list-style-type: none"> <li>· Athletic fit - provides contoured, slim silhouette</li> <li>· Performance stretch</li> <li>· Can be worn as a jersey, workout shirt or under a jersey</li> </ul>		Fit: Athletic Model Measurements: Ht: 5ft 9" Wearing Size Medium
FABRIC: 100% Polyester		
Decoration additional cost		



### EVOSHIELD® FX™ LONG SLEEVE TRAINING TEE

		MSRP
WTV9902	WOMEN: XS, S, M, L, XL, 2X	\$34.99
<ul style="list-style-type: none"> <li>· Athletic fit - provides contoured, slim silhouette</li> <li>· Performance stretch</li> <li>· Wear alone or layered</li> </ul>		Fit: Athletic Model Measurements: Ht: 5ft 9" Wearing Size Medium
FABRIC: 100% Polyester		
Decoration additional cost		



### EVOSHIELD® FX™ TRAINING TANK

		MSRP
WTV3003	WOMEN: S, M, L, XL, 2X	\$29.99
<ul style="list-style-type: none"> <li>· Athletic fit - provides contoured, slim silhouette</li> <li>· Performance stretch</li> <li>· Key hole back</li> </ul>		Fit: Athletic Model Measurements: Ht: 5ft 7" Wearing Size Small
FABRIC: 100% Polyester		
Decoration additional cost		



BACK DETAIL

# FASTPITCH TEAM APPAREL

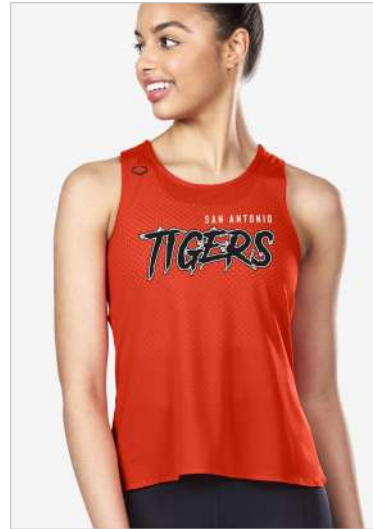

### NEW EVOSHIELD® TRAINING TANK

	WOMEN: XS, S, M, L, XL, 2X	
	Article No.	MSRP
Black	WB6016801	\$34. <sup>99</sup>
Citrine	WB6016802	\$34. <sup>99</sup>
Papaya	WB6016803	\$34. <sup>99</sup>
Pearl	WB6016804	\$34. <sup>99</sup>

- Athletic fit - provides contoured, slim silhouette
- Racerback

Fit: Athletic  
Model Measurements:  
Ht: 5ft 8"  
Chest: 34"  
Waist: 24"  
Hips: 34"  
Wearing Size X Small

FABRIC: 65% Nylon / 35% Spandex

Decoration additional cost



### NEW EVOSHIELD® FX™ TEAM FLEECE HOODIE

	WOMEN: XS, S, M, L, XL, 2X	
	Article No.	MSRP
Black	WB6017001	\$XX. <sup>99</sup>
Heather Grey	WB6017002	\$XX. <sup>99</sup>
Navy	WB6017003	\$XX. <sup>99</sup>
Royal	WB6017004	\$XX. <sup>99</sup>
Scarlet	WB6017005	\$XX. <sup>99</sup>
Team White	WB6017006	\$XX. <sup>99</sup>

- Relaxed fit allows for totally unrestricted range of motion
- Zippered kangaroo pocket
- Three-piece hood with drawcord
- Covered elastic bottom and sleeve ends
- Midweight fabric makes this a perfect year-round piece

FABRIC: TBD

Coming Late 2021

Decoration additional cost



### NEW EVOSHIELD® SHORT SLEEVE COOLING TEE

	WOMEN: XS, S, M, L, XL, 2X	
	Article No.	MSRP
Black	WB6017101	\$39. <sup>99</sup>
Navy	WB6017102	\$39. <sup>99</sup>
Royal	WB6017103	\$39. <sup>99</sup>
Scarlet	WB6017104	\$39. <sup>99</sup>
Team White	WB6017105	\$39. <sup>99</sup>

- Fitted - designed to tightly hug the shape of your body, without restricting movement
- Advanced fabric technology to keep you cool and dry
- UPF rated 50+ for sun protection
- Ergonomic flat seaming
- Moisture-wicking design helps keep you dry and cool

Fit: Fitted  
Model Measurements:  
Ht: 5ft 8"  
Chest: 34"  
Waist: 24"  
Hips: 34"  
Wearing Size X Small

FABRIC: 88% Polyester / 12% Spandex

Decoration additional cost



### EVOSHIELD® FX™ WOVEN TRAINING SHORT

	WOMEN: XS, S, M, L, XL, 2X	
	Article No.	MSRP
Black	WB6006101	\$39. <sup>99</sup>
Charcoal	WB6006102	\$39. <sup>99</sup>
Navy	WB6006103	\$39. <sup>99</sup>
Royal	WB6006104	\$39. <sup>99</sup>
Scarlet	WB6006105	\$39. <sup>99</sup>

- Athletic fit - provides contoured, slim silhouette
- 1 Rear pocket
- 4 1/4" inseam
- Interior circular drawcord

Fit: Athletic  
Model Measurements:  
Ht: 5ft 10"  
Waist: 28.5"  
Hips: 40"  
Wearing Size Medium

FABRIC: 88% Nylon / 12% Spandex Stretch Woven

Decoration additional cost



### NEW EVOSHIELD® LONG SLEEVE COOLING TEE

	WOMEN: XS, S, M, L, XL, 2X	
	Article No.	MSRP
Black	WB6007901	\$49. <sup>99</sup>
Navy	WB6007903	\$49. <sup>99</sup>
Royal	WB6007904	\$49. <sup>99</sup>
Scarlet	WB6007905	\$49. <sup>99</sup>
Team White	WB6007906	\$49. <sup>99</sup>

- Fitted - designed to tightly hug the shape of your body, without restricting movement
- Advanced fabric technology to keep you cool and dry
- UPF rated 50+ for sun protection
- Ergonomic flat seaming
- Moisture-wicking design helps keep you dry and cool

Fit: Fitted  
Model Measurements:  
Ht: 5ft 10"  
Chest: 34"  
Waist: 28.5"  
Hips: 40"  
Wearing Size Medium

FABRIC: 88% Polyester / 12% Spandex

Decoration additional cost



### EVOSHIELD® FX™ FLEECE JOGGER

WTV3070	WOMEN: S, M, L, XL, 2X	MSRP \$49.99
---------	------------------------	-----------------

- Jogger pant with relaxed fit
- 2 front pockets
- Soft logo waistband with outer drawcord

Fit: Relaxed  
Model Measurements:  
Ht: 5ft 9"  
Wearing Size Small

FABRIC: 60% Cotton / 40% Polyester Knit

Decoration additional cost



### EVOSHIELD® TERRY SWEATSHIRT

	WOMEN: XS, S, M, L, XL, 2X	
	Article No.	MSRP
Black	WB6006001	\$59.99
Heather Grey	WB6006002	\$59.99
Navy	WB6006003	\$59.99
Royal	WB6006004	\$59.99
Scarlet	WB6006005	\$59.99

- Athletic fit - provides contoured, slim silhouette
- Concealed front kangaroo pocket
- Drop shoulder
- Rib mock neck, cuffs, and hem
- Side vent

Fit: Athletic  
Model Measurements:  
Ht: 5ft 9.5"  
Chest: 36"  
Waist: 30"  
Hips: 41"  
Wearing Size Medium

FABRIC: 95% Cotton / 5% Spandex French Terry

Decoration additional cost



### EVOSHIELD® HYBRID HOODIE

	WOMEN: S, M, L, XL, 2X	
	Article No.	MSRP
Black	WB6001801	\$79.99
Grey	WB6001802	\$79.99
Navy	WB6001803	\$79.99

- Relaxed fit allows for totally unrestricted range of motion
- Full zip front with drawcord
- 2 front pockets
- Water resistant 3-piece hood, back and front pockets
- 4-way stretch

Fit: Relaxed  
Model Measurements:  
Ht: 5ft 8"  
Chest: 34"  
Waist: 24"  
Hips: 34"  
Wearing Size Small

FABRIC: 71% Cotton / 25% Polyester / 4% Spandex

Decoration additional cost



### EVOSHIELD® RACERBACK TANK

WTV3002	WOMEN: S, M, L, XL, 2X	MSRP \$17.99
---------	------------------------	-----------------

- Athletic fit - provides contoured, slim silhouette
- Heathered fabric
- Racerback cut gives you freedom to move
- Ribbed neck and armholes
- Contoured hem

Fit: Athletic  
Model Measurements:  
Ht: 5ft 7"  
Wearing Size Small

FABRIC: 52% Polyester / 48% Cotton Heathered Fabric

Decoration additional cost



### EVOSHIELD® KICK BACK PULLOVER

WTV3093HG	WOMEN: XS, S, M, L, XL, 2X	MSRP \$49.99
-----------	----------------------------	-----------------

- Relaxed fit allows for totally unrestricted range of motion
- Crew neck
- Raglan sleeves
- Kangaroo front pocket

Fit: Relaxed  
Model Measurements:  
Ht: 5ft 9"  
Wearing Size Medium

FABRIC: 52% Cotton / 48% Polyester French Terry

Decoration additional cost



### EVOSHIELD® SHORT SLEEVE

WOMEN: XS, S, M, L, XL, 2X		MSRP
WTV3001		\$19. <sup>99</sup>

- Athletic fit - provides contoured, slim silhouette
- Heathered fabric
- Ribbed crew neck

Fit: Athletic  
Model Measurements:  
Ht: 5ft 10"  
Chest: 34"  
Waist: 28.5"  
Hips: 40"  
Wearing Size Medium

FABRIC: 52% Polyester / 48% Cotton Heathered Fabric

Decoration additional cost



### EVOSHIELD® MID SLEEVE TEE

WOMEN: XS, S, M, L, XL, 2X		
	Article No.	MSRP
Charcoal/Black	WB6001001	\$24. <sup>99</sup>
Charcoal/Navy	WB6001002	\$24. <sup>99</sup>
Charcoal/Scarlet	WB6001003	\$24. <sup>99</sup>
Charcoal/Royal	WB6001004	\$24. <sup>99</sup>
Charcoal/Maroon	WB6001005	\$24. <sup>99</sup>
Charcoal/Purple	WB6001006	\$24. <sup>99</sup>
Charcoal/Dark Green	WB6001007	\$24. <sup>99</sup>

- Athletic fit - provides contoured, slim silhouette
- Raglan ¾ length sleeves
- Contrast body
- Rib crew neck

Fit: Athletic  
Model Measurements:  
Ht: 5ft 8"  
Chest: 34"  
Waist: 24"  
Hips: 34"  
Wearing Size Small

FABRIC: 52% Polyester / 48% Cotton Heathered fabric

Decoration additional cost



### NEW EVOSHIELD® FITTED LONG SLEEVE

WOMEN: XS, S, M, L, XL, 2X		
	Article No.	MSRP
Black	WB6017301	\$34. <sup>99</sup>
Pearl	WB6017302	\$34. <sup>99</sup>
Plum	WB6017303	\$34. <sup>99</sup>

- Fitted - designed to tightly hug the shape of your body, without restricting movement
- Crew neck

Fit: Fitted  
Model Measurements:  
Ht: 5ft 10"  
Chest: 34"  
Waist: 28.5"  
Hips: 40"  
Wearing Size Medium

FABRIC: 88% Nylon / 12% Spandex

Decoration additional cost



### NEW EVOSHIELD® CROP TEE

WOMEN: XS, S, M, L, XL, 2X		
	Article No.	MSRP
Light Grey	WB6017401	\$29. <sup>99</sup>
Pearl	WB6017402	\$29. <sup>99</sup>
Plum	WB6017403	\$29. <sup>99</sup>

- Relaxed fit allows for totally unrestricted range of motion
- Side vents

Fit: Relaxed  
Model Measurements:  
Ht: 5ft 8"  
Chest: 34"  
Waist: 24"  
Hips: 34"  
Wearing Size X Small

FABRIC: 88% Nylon / 12% Spandex

Decoration additional cost



### NEW EVOSHIELD® POP COLOR TERRY HOODIE

	WOMEN: XS, S, M, L, XL, 2X	
	Article No.	MSRP
Black [Fuchsia Pop Color]	WB6007401	\$59. <sup>99</sup>
Heather Grey [Cherry Red Pop Color]	WB6007402	\$59. <sup>99</sup>
Navy [Spring Green Pop Color]	WB6007403	\$59. <sup>99</sup>

- Athletic fit - provides contoured, slim silhouette
- Front kangaroo pocket
- Rib cuff and hem
- Three-piece hood
- Pop color drawcord and embroidered logo
- Pin tuck detailing
- Midweight fabric makes this a perfect year-round piece

Fit: Athletic  
Model Measurements:  
Ht: 5ft 10"  
Chest: 34"  
Waist: 28.5"  
Hips: 40"  
Wearing Size Medium

FABRIC: 95% Cotton / 5% Spandex French Terry

Decoration additional cost

### NEW EVOSHIELD® POP COLOR TERRY JOGGER

	WOMEN: XS, S, M, L, XL, 2X	
	Article No.	MSRP
Black [Fuchsia Pop Color]	WB6007301	\$59. <sup>99</sup>
Heather Grey [Cherry Red Pop Color]	WB6007302	\$59. <sup>99</sup>
Navy [Spring Green Pop Color]	WB6007303	\$59. <sup>99</sup>

- Athletic fit - provides contoured, slim silhouette
- Rib cuff
- Two front pockets
- Pintuck detailing
- Pop color drawcord and embroidered logo

Fit: Athletic  
Model Measurements:  
Ht: 5ft 10"  
Waist: 28.5"  
Hips: 40"  
Wearing Size Medium

FABRIC: 95% Cotton / 5% Spandex French Terry

Decoration additional cost



### EVOSHIELD® WOVEN JOGGER

	WOMEN: S, M, L, XL, 2X	
	Article No.	MSRP
Black	WB6006201	\$59. <sup>99</sup>
Charcoal	WB6006202	\$59. <sup>99</sup>
Navy	WB6006203	\$59. <sup>99</sup>

- Athletic fit
- Elastic cuffs
- 2 front pockets
- Additional side zippered pocket to stash essentials
- Exposed drawcord

Fit: Athletic  
Model Measurements:  
Ht: 5ft 10"  
Waist: 28.5"  
Hips: 40"  
Wearing Size Small

FABRIC: 88% Nylon / 12% Spandex Stretch Woven

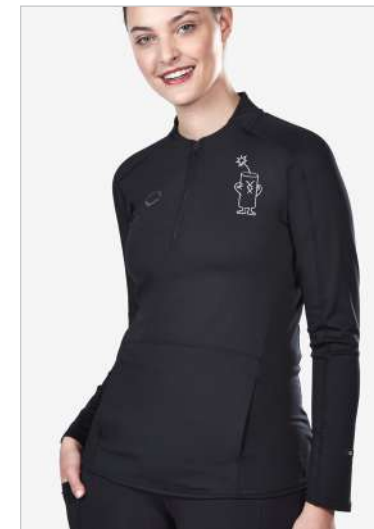

### EVOSHIELD® FX™ 1/2 ZIP

	WOMEN: XS, S, M, L, XL, 2X	
	Article No.	MSRP
Black	WTV3004BL	\$59. <sup>99</sup>
Team White	WTV3004TW	\$59. <sup>99</sup>

- Athletic fit - provides contoured, slim silhouette
- Raglan Sleeves
- 1/2 zip front
- Kangaroo front pocket
- 4-way stretch

Fit: Athletic  
Model Measurements:  
Ht: 5ft 10"  
Chest: 34"  
Waist: 28.5"  
Hips: 40"  
Wearing Size Medium

FABRIC: 90% Polyester / 10% Spandex Knit

Decoration additional cost

WILSON® · DEMARINI® · LOUISVILLE SLUGGER® · EVOSHIELD® · ATEC®

# THE WILSON TEAM SHOP ADVANTAGE.

Skip the hassle. Get started with Team Shop today and outfit your squad with team decorated gear and the best products from Wilson, DeMarini, Louisville Slugger, EvoShield, and ATEC.

[WILSONTEAMSHOP.COM](http://WILSONTEAMSHOP.COM)



- Exclusive team pricing
- No money collection or bill paying
- 24/7 access to stock goods at team discount
- One-stop shop for uniforms and apparel
- Free direct-to-player shipping
- Exclusive access to limited-edition product
- Direct customer service support

**W TEAM SHOP**



**W | EVOSHIELD | LS | WILSON**  
**HATS & PERSONAL PROTECTION**

HATS & PPE



### TEAM SHOP

Exclusively on wilsonteamshop.com



### NEW EVOSHIELD® XVT GAME HAT

SIZE: L/XL (7 1/8-7 3/4)	SIZE: S/M (7-7 1/4)	SIZE: XS/S (6 5/8-7)	MSRP
WB6001901	BLACK		\$24.99
WB6001902	CARDINAL		\$24.99
WB6001905	LIGHT GOLD		\$24.99
WB6001906	MAROON		\$24.99
WB6001907	NAVY		\$24.99
WB6001908	ORANGE		\$24.99
WB6001910	SCARLET		\$24.99
WB6001911	ROYAL		\$24.99
WB6001912	TEAM WHITE		\$24.99
WB6001913	VICTORY BLUE		\$24.99
WB6001914	WHITE/BLACK		\$24.99
WB6001916	WHITE/MAROON		\$24.99
WB6001918	WHITE/NAVY		\$24.99
WB6001920	WHITE/SCARLET		\$24.99
WB6001921	WHITE/ROYAL		\$24.99
WB6001922	WHITE/CARDINAL		\$24.99
WB6001923	WHITE/CHARCOAL		\$24.99
WB6001924	WHITE/LIGHT GOLD		\$24.99
WB6001925	WHITE/ORANGE		\$24.99
WB6001926	WHITE/VICTORY BLUE		\$24.99
WB6001927	TEXAS ORANGE		\$24.99
WB6001928	WHITE/TEXAS ORANGE		\$24.99
WB6001929	WHITE/DARK GREEN		\$24.99
WB6001930	WHITE/PURPLE		\$24.99
WB6001931	CHARCOAL		\$24.99
WB6001932	DARK GREEN		\$24.99
WB6001933	PURPLE		\$24.99

- Flexfit
  - Mid-rise profile
  - Lightweight with perforated panels
- FABRIC: 98% Polyester / 2% Spandex performance stretch

### TEAM SHOP

Exclusively on wilsonteamshop.com



### NEW EVOSHIELD® LYT GAME VISOR

SIZE: OSFA	MSRP
WB6021501	BLACK: ONE SIZE \$24.99
WB6021502	CARDINAL: ONE SIZE \$24.99
WB6021503	CHARCOAL: ONE SIZE \$24.99
WB6021504	DARK GREEN: ONE SIZE \$24.99
WB6021505	LIGHT GOLD: ONE SIZE \$24.99
WB6021506	MAROON: ONE SIZE \$24.99
WB6021507	NAVY: ONE SIZE \$24.99
WB6021508	ORANGE: ONE SIZE \$24.99
WB6021509	PURPLE: ONE SIZE \$24.99
WB6021510	SCARLET: ONE SIZE \$24.99
WB6021511	ROYAL: ONE SIZE \$24.99
WB6021512	TEAM WHITE: ONE SIZE \$24.99
WB6021513	VICTORY BLUE: ONE SIZE \$24.99
WB6021514	TEXAS ORANGE: ONE SIZE \$24.99

- Mid-rise profile
  - Lightweight with perforated panels
  - 2" front panel
  - Hook and loop closure
- FABRIC: 98% Polyester / 2% Spandex performance stretch



### TEAM SHOP

Exclusively on wilsonteamshop.com



### NEW EVOSHIELD® TEAM BUCKET HAT

SIZE: OSFA	MSRP
WB6020801	BLACK: ONE SIZE \$34.99
WB6020802	CHARCOAL: ONE SIZE \$34.99
WB6020803	NAVY: ONE SIZE \$34.99
WB6020804	ROYAL: ONE SIZE \$34.99
WB6020805	SCARLET: ONE SIZE \$34.99
WB6020806	TEAM WHITE: ONE SIZE \$34.99

- Wide brim helps shield the sun
- Laser cut holes and mesh vents in crown for breathability
- Adjustable strap and drawstring at the back for comfortable fit
- Open area for team decoration

FABRIC: 100% Polyester

### TEAM SHOP

Exclusively on wilsonteamshop.com



### NEW EVOSHIELD® LYT SNAPBACK

SIZE: OSFA	MSRP
WB6019501	BLACK: ONE SIZE \$29.99
WB6019502	CARDINAL: ONE SIZE \$29.99
WB6019503	CHARCOAL: ONE SIZE \$29.99
WB6019504	DARK GREEN: ONE SIZE \$29.99
WB6019505	LIGHT GOLD: ONE SIZE \$29.99
WB6019506	MAROON: ONE SIZE \$29.99
WB6019507	NAVY: ONE SIZE \$29.99
WB6019508	ORANGE: ONE SIZE \$29.99
WB6019509	PURPLE: ONE SIZE \$29.99
WB6019510	SCARLET: ONE SIZE \$29.99
WB6019511	ROYAL: ONE SIZE \$29.99
WB6019512	TEAM WHITE: ONE SIZE \$29.99
WB6019513	VICTORY BLUE: ONE SIZE \$29.99
WB6019514	TEXAS ORANGE: ONE SIZE \$29.99

- Mid-rise profile
- Pre-curved bill
- Snapback

FABRIC: 98% Polyester / 2% Polyurethane



### EVOSHIELD® TACKDOWN SNAPBACK

		MSRP
WB60065010SFA	BLACK: ONE SIZE	\$24.99
WB60065020SFA	CARDINAL: ONE SIZE	\$24.99
WB60065030SFA	NAVY: ONE SIZE	\$24.99

- Mid profile
- Pre-formed bill
- Snapback fit allows for full adjustability

FABRIC: 98% Polyester 2% PU Spandex

### EVOSHIELD® PRO PATCH SNAPBACK

		MSRP
WB60066010SFA	BLACK: ONE SIZE	\$24.99
WB60066020SFA	NAVY: ONE SIZE	\$24.99
WB60066030SFA	OLIVE: ONE SIZE	\$24.99
WB60066040SFA	TEAM WHITE: ONE SIZE	\$24.99

- Mid profile
- Pre-formed bill
- Snapback fit allows for full adjustability

FABRIC: 60% Cotton 40% Polyester



### EVOSHIELD® WOOL PATCH SNAPBACK

		MSRP
WB60082010SFA	BLACK: ONE SIZE	\$24.99
WB60082020SFA	MAROON: ONE SIZE	\$24.99
WB60082030SFA	NAVY: ONE SIZE	\$24.99

- Mid profile
- Pre-formed bill
- Snapback fit allows for full adjustability
- Comfort stretch sweatband

FABRIC: 85% Acrylic / 15% Wool / 2% PU Spandex



### EVOSHIELD® USA SNAPBACK TRUCKER

		MSRP
WTV1034320HG0SFM	HEATHER GREY/WHITE: ONE SIZE	\$24.99
WTV1034320620SFM	RED/WHITE: ONE SIZE	\$24.99
WTV1034320430SFM	ROYAL/WHITE: ONE SIZE	\$24.99

- Embroidered raised Evoshield® logo with American Flag design
- Breathable mesh back to keep you cool
- Snapback fit allows for full adjustability
- Imported

FABRIC: 53% Polyester / 47% Cotton



### EVOSHIELD® B.I.G. SNAPBACK

		MSRP
WTV8743BLOSFM	BLACK: ONE SIZE	\$24.99
WTV8743HG0SFM	HEATHER GREY: ONE SIZE	\$24.99
WTV8743NA0SFM	NAVY: ONE SIZE	\$24.99
WTV8743RO0SFM	ROYAL: ONE SIZE	\$24.99
WTV8743SC0SFM	SCARLET: ONE SIZE	\$24.99

- 3D embroidered Evoshield® logo
- Snapback fit allows for full adjustability
- High profile
- Breathable mesh back to keep you cool
- Flat bill allows you to shape to your preference

FABRIC: 80% Acrylic / 20% Wool

### EVOSHIELD® EST. 2005 OUTDOOR SNAPBACK

		MSRP
WTV8745CT0SFM	CARDINAL/TAN: ONE SIZE	\$24.99
WTV8745BG0SFM	COBALT BLUE/GREY: ONE SIZE	\$24.99
WTV8745GB0SFM	OLIVE/BLACK: ONE SIZE	\$24.99
WTV8745NV0SFM	NAVY/VICTORY BLUE: ONE SIZE	\$24.99

- Sonic Weld logo
- Snapback fit allows for full adjustability
- Mid profile
- Breathable mesh back to keep you cool
- Pre-formed bill

FABRIC: 60% Cotton / 40% Polyester



### FLAG PATCH SNAPBACK TRUCKER

		MSRP
WTV10373004100SFM	ONE SIZE	\$24.99

- Embroidered raised Evoshield® Stars and Seams flag
- Breathable mesh back to keep you cool
- Snapback fit allows for full adjustability
- Imported

FABRIC: 47% Nylon / 42% Acrylic / 11% Wool



WHITE/NAVY MESH

### EVOSHIELD® USA FLEXFIT® TRUCKER

SIZE: L/XL (7 1/4"-7 7/8")	SIZE: S/M (7-7 1/4")	MSRP
WTV1035320BLLGXL	WTV1035320BLSMMD	BLACK \$24.99
WTV1035320410LGXL	WTV1035320410SMMD	NAVY/WHITE \$24.99

- Evoshield® logo with American Flag design
- Breathable mesh back to keep you cool
- Flexfit band for ultimate comfort fit
- Pre-formed bill
- Imported

FABRIC: 56% Polyester / 42% Cotton / 2% P.U. Spandex





### EVOSHIELD® XVT FLEXFIT®

SIZE: L/XL (7 1/8"-7 3/4")		SIZE: S/M (7"-7 1/4")		MSRP
WTV8744BGLGXL	WTV8744BGSMMMD	BLACK/GOLD		\$24.99
WTV8744BLLGXL	WTV8744BLSMMMD	BLACK		\$24.99
WTV8744BWLGLXL	WTV8744BWSMMMD	BLACK/WHITE		\$24.99
WTV8744NWLGLXL	WTV8744NWSMMMD	NAVY/WHITE		\$24.99
WTV87440GLGXL	WTV87440GSMMMD	OLIVE		\$24.99
WTV8744RWLGLXL	WTV8744RWSMMMD	ROYAL/WHITE		\$24.99
WTV8744SWLGLXL	WTV8744SWSMMMD	SCARLET/WHITE		\$24.99
WTV8744USLGLXL	WTV8744USSMMMD	USA		\$24.99

- 3D embroidered Evoshield logo
- Flexfit band for ultimate comfort fit
- Laser cut holes with fabric backing
- Breathable mesh back to keep you cool
- Pre-formed bill

FABRIC: 60% Cotton / 40% Polyester



### EVOSHIELD® RANK FLEXFIT®

SIZE: L/XL (7 1/8"-7 3/4")		SIZE: S/M (7"-7 1/4")		MSRP
WTV8726NRLGXL	WTV8726NRSMMMD	NAVY/WHITE		\$24.99
WTV8747BWLGLXL	WTV8747BWSMMMD	BLACK/WHITE		\$24.99
WTV8747RWLGLXL	WTV8747RWSMMMD	ROYAL/WHITE		\$24.99
WTV8747SCLGXL	WTV8747SCSMMMD	SCARLET/CHARCOAL		\$24.99

- Features an embroidered sewn-on patch
- Flexfit band for ultimate comfort
- Breathable mesh back to keep you cool
- Pre-formed bill
- Imported

FABRIC: 63% Polyester / 34% Cotton / 3% P.U. Spandex



### EVOSHIELD® BUCKET HAT

			MSRP
WTV10360000560SFM	EVO CAMO: ONE SIZE		\$24.99
WTV10360001000SFM	WHITE: ONE SIZE		\$24.99
WTV1036CH0SFM	CHARCOAL: ONE SIZE		\$24.99
WTV1038WH0SFM	USA: ONE SIZE		\$24.99

- Wide brim helps shield the sun
- Laser cuts and mesh vents in crown for breathability
- Adjustable strap and drawstring at back for comfortable fit
- Embroidered Evoshield® logo

FABRIC: 100% Polyester



BLACK [01]

### WILSON® A2000® LIGHTWEIGHT SNAPBACK

		MSRP
WB6008701	BLACK: ONE SIZE	\$24.99

- Embroidered A2000® logo
- Snapback fit allows for full adjustability
- Lightweight
- Pre-formed bill

FABRIC: 98% Polyester / 2% Spandex



### WILSON® A2000® LEATHER PATCH SNAPBACK

		MSRP
WTA7115BLOSFM	BLACK: ONE SIZE	\$24.99
WTA7115CBOSFM	CHARCOAL: ONE SIZE	\$24.99
WTA7115ROOSFM	ROYAL: ONE SIZE	\$24.99
WTA7115SCOSFM	SCARLET: ONE SIZE	\$24.99
WTA7115USOSFM	USA: ONE SIZE	\$24.99

- Leather patch with printed A2000® logo
- Snapback fit allows for full adjustability
- Mid profile
- Breathable mesh back to keep you cool
- Pre-formed bill

FABRIC: 60% Cotton / 40% Polyester



### DEMARINI® RADIATION D® FLEXFIT™

LARGE/XL	SMALL/MEDIUM		MSRP
WTD1092BLLGXL	WTD1092BLSMMD	BLACK	\$24. <sup>99</sup>
WTD1092BCLGXL	WTD1092BCSMMD	BLACK/CHARCOAL	\$24. <sup>99</sup>
WTD1092BNLGXL	WTD1092BNSMMD	BLACK/NEON	\$24. <sup>99</sup>
WTD1092BOLGXL	WTD1092BOSMMD	BLACK/ORANGE	\$24. <sup>99</sup>
WTD1092BPLGXL	WTD1092BPSMMD	BLACK/PINK	\$24. <sup>99</sup>
WTD1092BWLGXL	WTD1092BWSMMD	BLACK/WHITE	\$24. <sup>99</sup>
WTD1092NWLGXL	WTD1092NWSMMD	NAVY/WHITE	\$24. <sup>99</sup>
WTD1092RWLGXL	WTD1092RWSMMD	ROYAL/WHITE	\$24. <sup>99</sup>
WTD1092SWLGXL	WTD1092SWSMMD	SCARLET/WHITE	\$24. <sup>99</sup>
WTD1092USLGXL	WTD1092USSMMD	USA	\$24. <sup>99</sup>

- 3D embroidered DeMarini® D® logo
- Flexfit band for ultimate comfort fit
- Laser cut holes with fabric backing
- Breathable mesh back to keep you cool
- Pre-formed bill

FABRIC: 60% Cotton / 40% Polyester



### SLUGGER® TPS® FLEXFIT™

LARGE/XL	SMALL/MEDIUM		MSRP
WTL8710BLLGXL	WTL8710BLSMMD	BLACK	\$24. <sup>99</sup>
WTL8710BPLGXL	WTL8710BPSMMD	BLACK/PINK	\$24. <sup>99</sup>
WTL8710BWLGXL	WTL8710BWSMMD	BLACK/WHITE	\$24. <sup>99</sup>
WTL8710CVLGXL	WTL8710CVSMMD	CHARCOAL/VICT. BLUE	\$24. <sup>99</sup>
WTL8710NWLGXL	WTL8710NWSMMD	NAVY/WHITE	\$24. <sup>99</sup>
WTL8710RCLGXL	WTL8710RCSMMD	ROYAL/CHARCOAL	\$24. <sup>99</sup>
WTL8710RWLGXL	WTL8710RWSMMD	ROYAL/WHITE	\$24. <sup>99</sup>
WTL8710SBLGXL	WTL8710SBSMMD	SCARLET/BLACK	\$24. <sup>99</sup>
WTL8710SWLGXL	WTL8710SWSMMD	SCARLET/WHITE	\$24. <sup>99</sup>
WTL8710USLGXL	WTL8710USSMMD	USA	\$24. <sup>99</sup>

- 3D embroidered LS® logo
- Flexfit band for ultimate comfort fit
- Mid profile
- Pre-formed bill

FABRIC: 98% Polyester / 2% PU Spandex



## PPE GEAR

In today's world, protection is more critical than ever. Ballplayers have always trusted EvoShield® on the diamond - and now, we're proud to offer a full line of PPE Gear to keep individuals and teams safe both on and off the field.



### NEW EVOSHIELD® GAITER FACE COVERING\*

	ADULT: SM, LXL	
	Article No.	MSRP
Black	WB6012601	\$14. <sup>99</sup>

- Flat back mesh material with moisture management properties to help keep the players cool
- Made from a soft, lightweight polyester
- Four-way breathable stretch fabric
- Masks will have the EvoShield logo sublimated on the exterior
- Wash after each use in hot water using detergent for disinfection
- 100% Polyester



### NEW EVOSHIELD® CLOTH FACE MASK\*

	ADULT: SM, LXL, 2XL		YOUTH: SM, LXL	
	Article No.	MSRP	Article No.	MSRP
Black	WB6012501	\$14. <sup>99</sup>	WB6012901	\$14. <sup>99</sup>

- Flat back mesh material with moisture management properties to help keep the players cool
- Two-ply masks with a slit to add a filter if the individual desires
- The design allows for the insertion any type of filter, filters will need to be replaced after each use
- Made from a soft, lightweight polyester
- Four-way breathable stretch fabric
- Masks will have the EvoShield logo sublimated on the exterior
- Wash after each use in hot water using detergent for disinfection
- 100% Polyester



### NEW EVOSHIELD® PPE FACE SHIELD\*

	ADULT: ONE SIZE	
Shield Quantity (specify)	Article No.	MSRP
Single	WTDXPPEFS1-21	\$29. <sup>95</sup>
3 pack	WTDXPPEFS1-21	\$79. <sup>95</sup>
6 pack	WTDXPPEFS1-21	\$149. <sup>95</sup>

- Two (2) clear shields come with each frame
- Offers increased protection from unwanted droplets or spray
- Lightweight and durable frame with adjustable straps for dialing in fit
- Padded frame for added comfort
- Shields can be quickly and easily cleaned or replaced as needed
- Designed to fit over most eyewear, N95 respirators or surgical masks
- Dishwasher safe, steam sterilizable
- Head Frame w/ Forehead Comfort Pad: Polypropylene (PP) + SEBS Elastomer
- Female/Male Strap Connections: SEBS Elastomer
- Clear Protective Shield: Polyester (PET)

\* Note: This is not a medical-grade mask and is not intended as a replacement for medical-grade equipment or other recommended measures to stop the community spread of any viruses. Please follow the guidelines outlined by the Centers for Disease Control and Prevention for medical-grade personal protective equipment.



